

CLASSIFICATION OF PLANAR RATIONAL CUSPIDAL CURVES

II. LOG DEL PEZZO MODELS

KAROL PALKA AND TOMASZ PEŁKA

ABSTRACT. Let $E \subseteq \mathbb{P}^2$ be a complex curve homeomorphic to the projective line. The Negativity Conjecture asserts that the Kodaira–Iitaka dimension of $K_X + \frac{1}{2}D$, where $(X, D) \rightarrow (\mathbb{P}^2, E)$ is a minimal log resolution, is negative. We prove structure theorems for curves satisfying this conjecture and we finish their classification up to a projective equivalence by describing the ones whose complements admit no \mathbb{C}^{**} -fibration. As a consequence, we show that they satisfy the Strong Rigidity Conjecture of Flenner–Zaidenberg. The proofs are based on the almost minimal model program. The obtained list contains one new series of bicuspidal curves.

1. MAIN RESULT

1A. *Main results and corollaries.*

We work with complex algebraic surfaces. Let $\bar{E} \subseteq \mathbb{P}^2$ be a curve homeomorphic, in the Euclidean topology, to the projective line. Such a curve is rational and *cuspidal*, because its singularities are locally analytically irreducible. In particular, its complement $\mathbb{P}^2 \setminus \bar{E}$ is \mathbb{Q} -acyclic. If this complement is not of log general type then there is a classification, for a summary see, for example, [Bod16a, §2.2] or [PP17, Lemma 2.14] and the references there. In particular, in this case \bar{E} has at most two cusps [Wak78] and $\mathbb{P}^2 \setminus \bar{E}$ has a \mathbb{C}^1 - or a \mathbb{C}^* -fibration [Pal19, Proposition 2.6]. Therefore, we shall assume that $\mathbb{P}^2 \setminus \bar{E}$ is of log general type, that is, $\kappa(K_X + D) = 2$, where (X, D) is a log smooth completion of $\mathbb{P}^2 \setminus \bar{E}$, and κ stands for the Kodaira–Iitaka dimension. As it was shown in loc. cit., in this case $\kappa(K_X + \frac{1}{2}D)$ plays a crucial role and one can study \bar{E} using the modification of the logarithmic Minimal Model Program, the so-called *almost Minimal Model Program* (see Section 2D), applying it to the pair $(X, \frac{1}{2}D)$. The guiding principle is the following conjecture, which strengthens the Coolidge–Nagata conjecture proved recently by M. Koras and the first author [Pal14, KP17].

Conjecture 1.1 (The Negativity Conjecture, [Pal19, Conjecture 4.7]). If (X, D) is a log smooth completion of a smooth \mathbb{Q} -acyclic surface then $\kappa(K_X + \frac{1}{2}D) = -\infty$.

For further motivation and evidence toward the Negativity Conjecture see Conjecture 2.5 in loc. cit. In [PP17] we have classified, up to a projective equivalence, rational cuspidal curves with complements admitting a \mathbb{C}^{**} -fibration, where $\mathbb{C}^{**} = \mathbb{C}^1 \setminus \{0, 1\}$, in which case Conjecture 1.1 holds automatically (see [Pal19, Lemma 2.4(iii)]). The goal of the current article is to complete the classification, up to a projective equivalence, of rational cuspidal curves for which Conjecture 1.1 holds.

Theorem 1.2. *Let $\bar{E} \subseteq \mathbb{P}^2$ be a complex curve homeomorphic to \mathbb{P}^1 , such that $\mathbb{P}^2 \setminus \bar{E}$ is of log general type. Then $\mathbb{P}^2 \setminus \bar{E}$ satisfies Negativity Conjecture 1.1 if and only if either:*

- (a) $\mathbb{P}^2 \setminus \bar{E}$ has a \mathbb{C}^{**} -fibration, hence \bar{E} is of one of the types listed in [PP17, Theorem 1.3], or
- (b) \bar{E} is of one of the types $\mathcal{Q}_3, \mathcal{Q}_4, \mathcal{FE}(\gamma), \mathcal{FZ}_2(\gamma), \mathcal{H}(\gamma), \mathcal{I}$ or $\mathcal{J}(k)$ listed in Definition 1.3.

Each of the above types is realized by a curve which is unique up to a projective equivalence.

For a summary of numerical characteristics of the above curves, see Table 1 at the end of this article and [PP17, Table 1]. Note that cases (a) and (b) correspond to the possible outcome of the birational part of the log MMP for $(X, \frac{1}{2}D)$, which is a log Mori fiber space over a curve in case (a) and a log del Pezzo surface of Picard rank one in case (b), see [Pal19, Theorem 4.5(4)].

The *multiplicity sequence* of a cusp $q \in \bar{E}$ consists of multiplicities of all proper transforms of the germ of \bar{E} at q under consecutive blowups within the minimal log resolution of q (often one omits 1’s at the end). We write $(m)_k$ for the sequence (m, \dots, m) of length k .

2010 *Mathematics Subject Classification.* Primary: 14H50; Secondary: 14J17, 14R05.

Research project funded by the National Science Centre, Poland, grant No. 2015/18/E/ST1/00562.

Definition 1.3 (Log del Pezzo series). Let $\bar{E} \subseteq \mathbb{P}^2$ be a curve homeomorphic to \mathbb{P}^1 (hence rational cuspidal). We say that it is of type \mathcal{Q}_3 , \mathcal{Q}_4 , \mathcal{FE} , \mathcal{FZ}_2 , \mathcal{H} , \mathcal{I} , \mathcal{J} if the multiplicity sequences of its cusps are, respectively,

$$\mathcal{Q}_3 : (2, 2), (2, 2), (2, 2),$$

$$\mathcal{Q}_4 : (2, 2, 2), (2), (2), (2),$$

$$\mathcal{FE}(\gamma) : (3(\gamma - 3), (3)_{\gamma-3}), ((4)_{\gamma-3}, 2, 2), (2) \text{ for some integer } \gamma \geq 5,$$

$$\mathcal{FZ}_2(\gamma) : (2(\gamma - 2), (2)_{\gamma-2}), ((3)_{\gamma-2}), (2) \text{ for some integer } \gamma \geq 4,$$

$$\mathcal{H}(\gamma) : (3(\gamma - 1), (3)_{\gamma-1}), ((4)_{\gamma-1}, 2, 2, 2) \text{ for some integer } \gamma \geq 3,$$

$$\mathcal{I} : (6, 6, 3, 3), (8, 4, 4, 2, 2),$$

$$\mathcal{J}(k) : (2k, 2k, 2k, (2)_k), (2k, (2)_k) \text{ for some integer } k \geq 2.$$

By Lemma 2.10, the integers $\deg \bar{E}$ and E^2 , where E is the proper transform of \bar{E} on X , are uniquely determined by the multiplicity sequences, see Table 1 at the end of the article.

As a consequence of our classification we infer that all rational cuspidal curves with complements of log general type which satisfy Negativity Conjecture 1.1 share some unexpected geometric properties. We summarize these properties in Theorems 1.4 and 1.6, see Section 5 for proofs. We use the names of series \mathcal{FZ}_1 and $\mathcal{A} - \mathcal{G}$ from [PP17] and the ones from Definition 1.3 above. For $k \geq 1$ we denote by $\mathcal{OR}_1(k)$ and $\mathcal{OR}_2(k)$ the curves C_{4k} and C_{4k}^* , a part of the series constructed by Orevkov [Ore02] for which the complements are of log general type.

Theorem 1.4 (Existence of special lines). *Let $\bar{E} \subseteq \mathbb{P}^2$ be a rational cuspidal curve with a complement of log general type, and which is not one of the Orevkov unicuspidal curves \mathcal{OR}_1 , \mathcal{OR}_2 . Assume that Negativity Conjecture 1.1 holds for $\mathbb{P}^2 \setminus \bar{E}$. Then \bar{E} has two, three or four cusps and there exists a line ℓ through a cusp $q_1 \in \bar{E}$ with the largest multiplicity sequence (in the lexicographic order) meeting \bar{E} only in two points. Hence, \bar{E} is the closure of the image of a proper injective morphism $\mathbb{C}^* \rightarrow \mathbb{C}^2$ given by $\bar{E} \setminus \ell \subseteq \mathbb{P}^2 \setminus \ell$.*

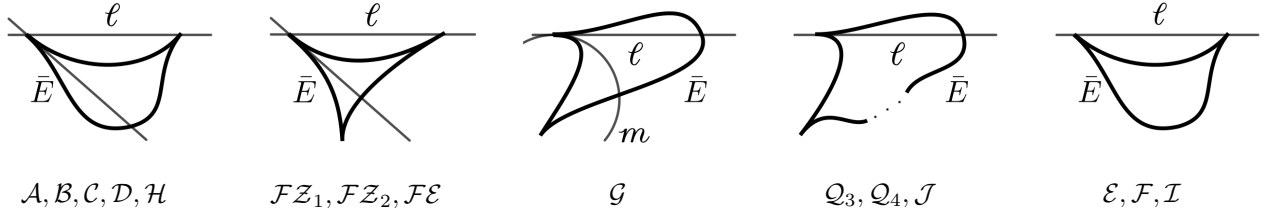

FIGURE 1. Configurations $(\mathbb{P}^2, \bar{E} + \ell)$ from Theorem 1.4.

More precisely, exactly one of one of the following cases (a)–(c) hold, see Figure 1.

- There are at least two lines ℓ as above. In this case, one of these lines passes through two cusps of \bar{E} and some other meets $\bar{E} \setminus \{q_1\}$ transversally. Moreover, \bar{E} is of type $\mathcal{A}, \mathcal{B}, \mathcal{C}, \mathcal{D}$ or \mathcal{H} if it has two cusps and is of type \mathcal{FZ}_1 , \mathcal{FZ}_2 or \mathcal{FE} otherwise.
- There exists a unique line ℓ as above and there exists a curve m such that $m \setminus \ell \cong \mathbb{C}^1$ and m meets $\bar{E} \setminus \ell$ in one point, transversally. In this case, ℓ meets $\bar{E} \setminus \{q_1\}$ transversally, and there is exactly one curve m as above. That m is a conic. Moreover, \bar{E} is of type \mathcal{G} .
- There is a unique line ℓ as above and every curve in $\mathbb{P}^2 \setminus \ell$ isomorphic to \mathbb{C}^1 meets $\bar{E} \setminus \ell$ at least twice in the sense of intersection theory. In this case, \bar{E} is of type \mathcal{Q}_3 , \mathcal{Q}_4 or \mathcal{J} if ℓ passes through exactly one cusp and is of type \mathcal{E} , \mathcal{F} or \mathcal{I} otherwise.

Remark 1.5 (Existence of \mathbb{C}^* in the complement).

- Let $\bar{E} \subseteq \mathbb{P}^2$ be any rational cuspidal curve. It is known (see [PP17, Lemma 2.4]) that $\mathbb{P}^2 \setminus \bar{E}$ is of log general type if and only if it does not contain a curve isomorphic to \mathbb{C}^1 . But in the latter case (under our assumption that the Negativity Conjecture holds) it turns out that $\mathbb{P}^2 \setminus \bar{E}$ always contains a curve isomorphic to \mathbb{C}^* . Indeed, for the Orevkov curves it is the affine part of a certain nodal cubic with a node at the cusp of \bar{E} , see [Ore02, §6], and for the remaining types it is $\ell \setminus \bar{E}$. Another example of $\mathbb{C}^* \subseteq \mathbb{P}^2 \setminus \bar{E}$ is $\ell_1 \setminus \bar{E}$ or $m \setminus \bar{E}$, where ℓ_1, m are the tangent line and the conic from Theorem 1.4(a),(b), respectively (see Remark 4.15 for other examples).

- (b) For the bicuspidal curves in Theorem 1.4(a) the line meeting $\bar{E} \setminus \ell$ once is a *good asymptote* in the sense of [CNKR09, Definition 1.1] for the \mathbb{C}^* -embedding $\bar{E} \setminus \ell \subseteq \mathbb{P}^2 \setminus \ell$.

Using the above classification together with known results for smooth \mathbb{Q} -acyclic surfaces we deduce the following important geometric consequences, parts (a) and (b) being results toward the tom Dieck conjecture [tD92, Conjecture 2.14] and the Orevkov–Piontkowski conjecture [Pio07], respectively. Recall that the logarithmic tangent sheaf of (X, D) , denoted by $\mathcal{T}_X(-\log D)$, is the sheaf of the \mathcal{O}_X -derivations which preserve the ideal sheaf of D .

Theorem 1.6 (Geometric properties of planar rational cuspidal curves). *Let $\bar{E} \subseteq \mathbb{P}^2$ be a curve homeomorphic to \mathbb{P}^1 and let $(X, D) \rightarrow (\mathbb{P}^2, \bar{E})$ be a minimal log resolution. In case $\mathbb{P}^2 \setminus \bar{E}$ is of log general type assume that it satisfies Negativity Conjecture 1.1. Then the following hold.*

- (a) (Fibrations) $\mathbb{P}^2 \setminus \bar{E}$ has a fibration over \mathbb{P}^1 or \mathbb{C}^1 with general fiber isomorphic to \mathbb{C}^1 , \mathbb{C}^* , \mathbb{C}^{**} or \mathbb{C}^{***} . In the three latter cases one can choose a fibration with no base point on X .
- (b) (The number of cusps) \bar{E} has at most four singular points (cusps), and if it has exactly four then it is projectively equivalent to the quintic which is the closure of

$$\mathbb{C}^1 \ni t \mapsto [t : t^3 - 1 : t^5 + 2t^2] \in \mathbb{P}^2.$$

- (c) (A special line) If \bar{E} has at least two cusps then there is a line meeting \bar{E} in at most two points.
- (d) (Strong Rigidity) We have $H^2(\mathcal{T}_X(-\log D)) = 0$. In particular, for planar rational cuspidal curves the Negativity Conjecture implies the Flenner–Zaidenberg Strong Rigidity Conjecture (see Conjecture 5.2).

1B. Discussion of some results in the literature.

We now comment on the curves from Definition 1.3. The curves \mathcal{Q}_3 and \mathcal{Q}_4 appear as a part of a classification of planar quintics [Nam84, Theorem 2.3.10]. The curves \mathcal{FZ}_2 were constructed by Flenner and Zaidenberg [FZ00], who showed that they are the only rational tricuspidal curves with $\mu = \deg \bar{E} - 3 \geq 3$, where μ is the maximal multiplicity of a cusp of \bar{E} . The curves \mathcal{FE} were constructed by Fenske [Fen99], who showed that they are the only rational tricuspidal curves with $\mu = \deg \bar{E} - 4 \geq 3$ and $\chi(\mathcal{T}_X(-\log D)) \leq 0$. For both series projective uniqueness has been settled in these articles. Note that in general the difference $\deg \bar{E} - \mu$ can be arbitrarily large, for example for the curves $\mathcal{J}(k)$ it equals $2k + 1$.

The curves \mathcal{H} and \mathcal{I} are closures in \mathbb{P}^2 of specific proper embeddings of \mathbb{C}^* into \mathbb{C}^2 . The classification of such embeddings was initiated by Cassou-Nogues, Koras and Russell [CNKR09] and will be completed in a forthcoming article of Koras and the first author [KP16]. Type \mathcal{H} corresponds to [CNKR09, Theorem 8.2(ii.3)]. See Remarks 4.11, 4.12(a),(b),(c) and 4.17(a) for a comparison with the conditional classification of Borodzik and Żołądek [BZ10].

It turns out that almost all curves in our classification have been already discovered. However, in Section 4D we construct one new series of rational bicuspidal curves with complements of log general type, the series $\mathcal{J}(k)$, depending on a natural number $k \geq 2$. Independently from us, it was recently described by Bodnár [Bod16b, Theorem 3.1(c)]. In fact, as we were told by M. Zaidenberg, it was most likely known to T. tom Dieck in 1995, see Remark 4.17(b).

1C. Scheme of the proof.

In Section 3 we show that if $\mathbb{P}^2 \setminus \bar{E}$ satisfies Negativity Conjecture 1.1 but admits no \mathbb{C}^{**} -fibration then $\bar{E} \subseteq \mathbb{P}^2$ is of one of the types described in Definition 1.3. The main tool is the “almost MMP” for the pair $(X_0, \frac{1}{2}D_0)$, where $(X_0, D_0) \rightarrow (\mathbb{P}^2, \bar{E})$ is the minimal weak resolution of singularities (see Section 2C). In this article, by a minimal model we mean the outcome of a birational part of the log MMP. Under our assumptions some minimal model (in fact, every minimal model) $(X_{\min}, \frac{1}{2}D_{\min})$ of $(X_0, \frac{1}{2}D_0)$ is a log del Pezzo surface of Picard rank one, which strongly restricts the geometry of D_{\min} . In particular, D_{\min} has at most six components (see [Pal19, Theorem 4.5(4)]). In Section 3A we find further restrictions by exploiting the fact that the connected components of $D_0 - E_0$ can be contracted to smooth points. The proof is then divided into two parts, depending on whether X_{\min} itself is singular or not. The first case is treated in Section 3B: it turns out that X_{\min} is the quadric cone and \bar{E} is of type \mathcal{FE} or \mathcal{I} . In the second case, treated in Section 3C, we have $X_{\min} \cong \mathbb{P}^2$ and D_{\min} is a simple configuration of at most four curves. These configurations lead to types \mathcal{Q}_3 or \mathcal{Q}_4 if $(\mathbb{P}^2, \frac{1}{2}\bar{E})$ is already minimal (see Proposition 3.13) and to types \mathcal{FZ}_2 , \mathcal{H} and \mathcal{J} otherwise.

In Section 4A we prove that, conversely, if the singularity type of \bar{E} is as in Definition 1.3 then $\mathbb{P}^2 \setminus \bar{E}$ is a surface of log general type which satisfies Negativity Conjecture 1.1 and has no \mathbb{C}^{**} -fibration. In

Sections 4B - 4D we prove the existence and the projective uniqueness of such curves. In cases \mathcal{FZ}_2 , \mathcal{FE} and \mathcal{H} this result is already known. In the remaining cases we show how to deduce the uniqueness using the original constructions or the almost MMP described in Section 3. Theorems 1.4 and 1.6 are proved in Section 5.

CONTENTS

- 1. Main result 1
 - 1A. Main results and corollaries. 1
 - 1B. Discussion of some results in the literature. 3
 - 1C. Scheme of the proof. 3
- 2. Preliminaries 4
 - 2A. Log surfaces. 4
 - 2B. Fibrations. 6
 - 2C. Log resolutions of rational cuspidal curves. 6
 - 2D. Almost minimal models with half-integral boundaries. 9
 - 2E. Consequences of non-existence of a \mathbb{C}^{**} -fibration. 12
- 3. Possible types of cusps 15
 - 3A. Restrictions on the geometry of almost minimal models. 15
 - 3B. Types with a singular minimal model. 21
 - 3C. Types with a smooth minimal model. 25
- 4. Existence and uniqueness 32
 - 4A. The Kodaira–Itaka dimension. 33
 - 4B. Existence and uniqueness for types \mathcal{Q}_3 and \mathcal{Q}_4 34
 - 4C. Existence and uniqueness for types \mathcal{FZ}_2 , \mathcal{FE} and \mathcal{H} 37
 - 4D. Existence and uniqueness for types \mathcal{I} and \mathcal{J} 38
 - 4E. A direct proof of nonexistence of \mathbb{C}^{**} -fibrations. 41
- 5. Geometric consequences 43
 - 5A. Proof of Theorem 1.4. 43
 - 5B. Log deformations and the proof of Theorem 1.6. 47
- TABLE: Classification (del Pezzo case) 49
- References 50

2. PRELIMINARIES

2A. *Log surfaces.*

This article is a continuation of [PP17]. We use the terminology and notation introduced there, which we now briefly recall.

Let D be a reduced effective divisor on a smooth projective surface X . By a *component* of D we mean an irreducible component. We denote the number of such components by $\#D$. If D' is an effective *subdivisor* of D , that is, $D - D'$ is effective, we define its *branching number* as

$$\beta_D(D') = D' \cdot (D - D').$$

We say that a component T of D is a *tip* of D if $\beta_D(T) \leq 1$. If $\beta_D(T) \geq 3$ we say that T is a *branching component* of D .

By a *curve* we mean an irreducible and reduced variety of dimension 1. A smooth complete rational curve L on X with self-intersection number $L^2 = n$ is called an n -curve. For such a curve $K_X \cdot L = -n - 2$ by adjunction. We say that D has *simple normal crossings* (is *snc*) if all its components are smooth and meet transversally, at most two in one point. If D is *snc*, a (-1) -curve $L \subseteq D$ is called *superfluous* for D if $0 < \beta_D(L) \leq 2$ and L meets two different components of $D - L$ in case $\beta_D(L) = 2$. Note that a (-1) -curve $L \subseteq D$ is *superfluous* if and only if it is not a connected component of D and after its contraction the image of D remains *snc*.

Let D_1, \dots, D_n be the components of D . We say that D is *negative definite* if its intersection matrix $[D_i \cdot D_j]_{1 \leq i, j \leq n}$ is *negative-definite*. A *discriminant* of D is defined as

$$d(D) = \det[-D_i \cdot D_j]_{1 \leq i, j \leq n} \quad \text{if } D \neq 0 \quad \text{and} \quad d(0) = 1,$$

see [Fuj82, Section 3] for its elementary properties. If D has a connected support and for all its components $\beta_D \leq 2$ then we say that D is a *chain* in case at least one inequality is strict and that D is *circular* otherwise. An snc-divisor is a (*rational*) *tree* if it has a connected support and contains no circular subdivisor (and its components are rational). The components T_1, \dots, T_m of a chain T can be ordered in such a way that $T_i \cdot T_{i+1} = 1$ for $i = 1, \dots, m-1$. Then T_1 and T_m are, respectively, the *first* and the *last* tip of T . We denote them by

$$\text{tip}^+(T) \text{ - the first tip of } T, \quad \text{tip}^-(T) \text{ - the last tip of } T.$$

A *type* of such an ordered chain is the sequence of integers $[-T_1^2, \dots, -T_m^2]$. We will often abuse the notation and write $T = [-T_1^2, \dots, -T_m^2]$. We denote by T^t the same chain with an opposite ordering. A non-zero ordered chain $T \subseteq D$ is called a *twig* of D if $\text{tip}^+(T)$ is a tip of D and the components of T are non-branching in D . A twig T of D is *maximal* if it is maximal in the set of twigs of D ordered by inclusion. A rational tree with one branching component and three maximal twigs is called a *fork*.

Let us recall the notion of a *bark*. Let D be a reduced effective divisor with no superfluous (-1) -curves and let T be a rational negative definite twig of D . The *bark* of T in D , denoted by $\text{Bk}_D(T)$, is defined in [Miy01, Section II.3.3] as a unique \mathbb{Q} -divisor supported on T such that for every component T_0 of T one has

$$(2.1) \quad T_0 \cdot \text{Bk}_D(T) = \beta_D(T_0) - 2,$$

see Lemma II.3.3.4 loc.cit. Equivalently, $T_0 \cdot \text{Bk}_D(T) = -1$ if $T_0 = \text{tip}^+(T)$ and $T_0 \cdot \text{Bk}_D(T) = 0$ otherwise. One shows that for twigs the coefficients of barks are positive and smaller than 1.

If T is a disjoint sum of some twigs of D we define its bark $\text{Bk}_D(T)$ as the sum of respective barks. In this article, we will use mostly the barks of (-2) -twigs, that is, of twigs whose components are (-2) -curves. If $T = T_1 + \dots + T_k$ is a (-2) -twig of D then we check that

$$(2.2) \quad \text{Bk}_D(T) = \sum_{i=1}^k \frac{k-i+1}{k+1} T_i.$$

We have the following result on chains contractible to smooth points. A similar description was given in [Pal14, Lemma 3.7] and [Ton12a, Proposition 10].

Lemma 2.1 (Chains contractible to smooth points). For every chain which has a unique (-1) -curve and is contractible to a smooth point there is a unique choice of an ordering and unique integers $l \geq 0$, $m_1, m_2, \dots, m_l, x \geq 0$, such that the type of the ordered chain is:

$$\begin{aligned} & [(2)_{m_l}, m_{l-1} + 3, \dots, m_2 + 3, (2)_{m_1+1}, 1, m_1 + 3, (2)_{m_2}, \dots, m_l + 3, (2)_x], \quad \text{where } 2 \nmid l \\ \text{or } & [(2)_{m_l}, m_{l-1} + 3, \dots, m_1 + 3, 1, (2)_{m_1+1}, m_2 + 3, (2)_{m_3}, \dots, m_l + 3, (2)_x], \quad \text{where } 2 \mid l. \end{aligned}$$

Proof. Let T be a chain which has a unique (-1) -curve and contracts to a smooth point. We may assume $T \neq [1]$ and $T \neq [1, 2]$, for otherwise the type of T is one of the above sequences. The contraction of T can be decomposed into a sequence of contractions of (-1) -curves in T and its successive images. Let T' be the image of T after the first contraction. By induction we may assume that with some choice of an ordering the type of T' is one of the above sequences. It contains a unique subsequence $[a, 1, b]$ for some $b \geq 2$ and $a \geq 2$ or $a = -\infty$, where we put $[-\infty, 1] = [1]$. Note that $a = -\infty$ if and only if $l = 0$. The type of T can be obtained from the type of T' by replacing $[a, 1, b]$ with $[a+1, 1, 2, b]$ or $[a, 2, 1, b+1]$. Since the set of the above sequences is closed under such replacements, it contains the type of T for some choice of an ordering on T . Moreover, the number l is the number of components of T which are not (-1) - or (-2) -curves. For $l \neq 0$ we have $m_1 + 1 \geq 1$, so the parity of l determines the side of 1 on which the nearest 2 stands in the sequence. It follows that T has a unique ordering such that its type is one of the above sequences.

Now, assume that two presentations with m_1, \dots, m_l, x and m'_1, \dots, m'_l, x' as above give the same sequence. By deleting terms equal to 1 or 2 and subtracting 3 from the remaining terms we get

$$[m_{l-1}, m_{l-3}, \dots, m_2, m_1, \dots, m_l] = [m'_{l-1}, m'_{l-3}, \dots, m'_2, m'_1, \dots, m'_l]$$

for l odd and

$$[m_{l-1}, m_{l-3}, \dots, m_1, m_2, \dots, m_l] = [m'_{l-1}, m'_{l-3}, \dots, m'_1, m'_2, \dots, m'_l]$$

for l even, hence $m_i = m'_i$ for $i = 1, \dots, l$ and then $x = x'$. \square

Let $\sigma: X \rightarrow X'$ be a birational morphism between smooth projective surfaces. The reduced exceptional divisor of σ will be denoted by $\text{Exc } \sigma$. A point of X' is called a *center* of σ if it is a base point of

σ^{-1} . We define the *rank* of σ as $\rho(\sigma) = \rho(X) - \rho(X')$, which is the number of curves contracted by σ . A *part* of σ is any morphism $\sigma': X \rightarrow X''$ such that there is a factorization $\sigma = \sigma'' \circ \sigma'$.

We can write σ as a composition of blowups $\sigma = \sigma_1 \circ \cdots \circ \sigma_z$ for some $z \geq 0$. If L is a reduced effective divisor on X then we say that σ *touches* L if it is not an isomorphism in every neighborhood of L (in particular, σ touches $\text{Exc } \sigma$). We say that σ *touches* L n *times* for some $n \geq 0$ if $L \not\subseteq \text{Exc } \sigma$, exactly n of the blowups $\sigma_z, \dots, \sigma_1$ touch the image of L and each exceptional divisor meets the respective image of L in one point, with multiplicity one. In this case, $(\sigma_*L)^2 = L^2 + n$.

Given two divisors Z_1 and Z_2 on the same surface we denote by $Z_1 \wedge Z_2$ the divisor which is the sum of their common components. By $Z_1 \cap Z_2$ we denote the intersection of their supports, which may contain components of codimension 2.

2B. Fibrations.

A *fibration* of a smooth surface X is a surjective morphism $X \rightarrow B$ onto a curve with a connected, reduced and irreducible scheme-theoretic general fiber. For a given fibration with general fiber F , we say that an (irreducible) curve C is *vertical* (resp. *horizontal*) if $C \cdot F = 0$ (resp. $C \cdot F \neq 0$). A horizontal curve C with $C \cdot F = n$ is called an n -*section*. For a vertical curve C we denote by $\mu(C)$ the multiplicity of C in the fiber containing C . Every divisor T can be uniquely decomposed as $T = T_{\text{vert}} + T_{\text{hor}}$, where all components of T_{vert} are vertical and all components of T_{hor} are horizontal.

A \mathbb{P}^1 - (respectively, \mathbb{C}^1 -, \mathbb{C}^* -, \mathbb{C}^{**} -) fibration is a fibration with general fiber isomorphic to \mathbb{P}^1 (respectively, \mathbb{C}^1 , $\mathbb{C}^* = \mathbb{C}^1 \setminus \{0\}$, $\mathbb{C}^{**} = \mathbb{C}^1 \setminus \{0, 1\}$). A fiber non-isomorphic to the general one is called a *degenerate fiber*. Every degenerate fiber of a \mathbb{P}^1 -fibration can be contracted to a 0-curve by iterated contractions of (-1) -curves. By induction one easily gets the following result (see [Fuj82, Section 4]).

Lemma 2.2 (Degenerate fibers). Let F be a degenerate fiber of a \mathbb{P}^1 -fibration of a smooth projective surface. Then F is a rational tree and its (-1) -curves are non-branching in F_{red} . Furthermore,

- (a) If a (-1) -curve L is a component of F and $\mu(L) = 1$ then $\beta_{F_{\text{red}}}(L) = 1$ and F contains another (-1) -curve.
- (b) If F has a unique (-1) -curve L then F has exactly two components of multiplicity one and they are tips of F . If these components belong to different connected components of $F_{\text{red}} - L$ then F_{red} is a chain $U + [1] + U^*$, where U^* is *adjoint* to U [Fuj82, 3.9]; in particular, $d(U) = d(U^*)$.

Notation 2.3 (\mathbb{P}^1 -fibrations). Let D be a reduced effective divisor on a smooth projective surface X and let $p: X \rightarrow B$ be a \mathbb{P}^1 -fibration. Let ν be the number of fibers contained in D . For $b \in B$, let $\sigma(F_b)$ denote the number of components of $F_b = p^{-1}(b)$ which are not contained in D .

Lemma 2.4 ([Fuj82, 4.16], cf. [Pal15, Lemma 2]). Fix the notation as above and put $B^* = \{b \in B : F_b \not\subseteq D\}$. Then

$$\#D_{\text{hor}} + \nu + \rho(X) = \#D + 2 + \sum_{b \in B^*} (\sigma(F_b) - 1).$$

2C. Log resolutions of rational cuspidal curves.

We now fix some notation for the remaining part of the article. By $\bar{E} \subseteq \mathbb{P}^2$ we denote a rational cuspidal curve. Let

$$\pi_0: (X_0, D_0) \rightarrow (\mathbb{P}^2, \bar{E})$$

be the minimal weak resolution of singularities, that is, a composition of a minimal number of blowups such that the proper transform E_0 of \bar{E} on X_0 is smooth. We will also use the minimal log resolution

$$\pi: (X, D) \rightarrow (\mathbb{P}^2, \bar{E}),$$

that is, a composition of a minimal number of blowups such that $D = (\pi^*\bar{E})_{\text{red}}$ is snc. It factors as $\pi = \pi_0 \circ \psi_0$. We put $E = (\pi^{-1})_*\bar{E} \subseteq X$. We assume that the surface $X \setminus D$ is of log general type. Of course, $X \setminus D = X_0 \setminus D_0 = \mathbb{P}^2 \setminus \bar{E}$. By the Poincaré-Lefschetz duality $\mathbb{P}^2 \setminus \bar{E}$ is \mathbb{Q} -acyclic, that is, $b_i(\mathbb{P}^2 \setminus \bar{E}) = 0$ for $i > 0$. We will frequently use the following consequence of the logarithmic version of the Bogomolov-Miyaoka-Yau inequality:

Lemma 2.5 (No affine lines, [MT92]). A smooth \mathbb{Q} -acyclic surface of log general type contains no curve isomorphic to \mathbb{C}^1 .

By E_0 we denote the proper transform of \bar{E} on X_0 . For simplicity assume for now that \bar{E} has only one cusp $q \in \bar{E}$ and let Q be the reduced preimage of q on X_0 . We have a unique decomposition $\pi_0 = \sigma_1 \circ \dots \circ \sigma_k$, where σ_i are blowdowns (note the order of indices), or equivalently

$$(2.3) \quad \pi_0^{-1} = \sigma_k^{-1} \circ \dots \circ \sigma_1^{-1}.$$

The latter decomposition orders linearly the components of Q as exceptional divisors of the successive blowups (the first component is the one created by the first blowup, or equivalently, contracted last by the resolution morphism). Similarly, the decomposition of π^{-1} orders linearly the components of the exceptional divisor of the minimal log resolution over q and this order extends the one on the proper transform of Q . If $Z \neq 0$ is a reduced snc-divisor then a blowup of a point on Z is called *inner for Z* if it is centered at a singular point of Z , otherwise it is called *outer*. The first blowup over q is neither outer nor inner.

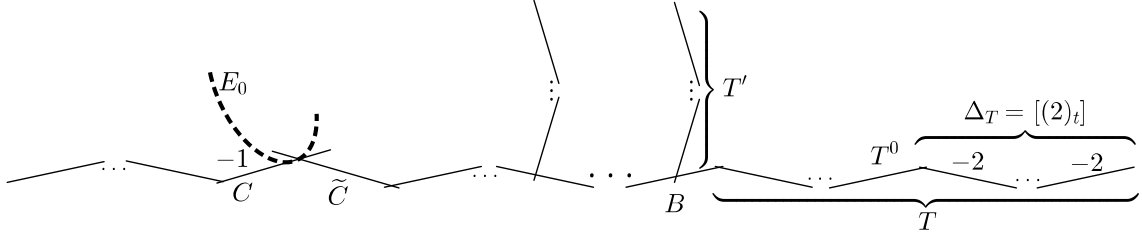

FIGURE 2. Exceptional divisor Q of the minimal weak resolution of a cusp $q \in \bar{E}$.

Recall that a *maximal (-2) -twig* is a (-2) -twig which is not properly contained in any other (-2) -twig. In particular, a maximal (-2) -twig is not necessarily a maximal twig.

Notation 2.6 (The geometry of the minimal weak resolution). We define the following quantities describing the geometry of the cusp $q \in \bar{E}$ (see Figure 2):

- C is the last component of Q , that is, the unique (-1) -curve in Q .
- $\tau := C \cdot E_0 \geq 2$.
- The component of $Q - C$ meeting E_0 is denoted by \tilde{C} . We put $\tilde{C} = 0$ if there is no such.
- $s = 1$ if $\tilde{C} = 0$ and $s = 0$ otherwise.
- B is the proper transform of the exceptional curve of the last blowup for which the total exceptional divisor over q is still a chain.
- T is the twig of Q meeting (and not containing) B which contains the first component of Q . We put $T = 0$ if there is no such (then $Q = B = C$).
- If T contains no (-2) -twigs of D_0 we put $\Delta_T = 0$, otherwise we denote by Δ_T the maximal (-2) -twig of D_0 contained in T . We put $t = \#\Delta_T$.
- T^0 is the exceptional curve of the $(t + 1)$ -st blowup.
- T' is the second (not contained in T) twig of Q meeting B . We put $T' = 0$ if there is no such (then B is a tip of Q).

It is known, and easy to see by induction, see for example [PP17, Lemmas 2.11 and 2.12], that the multiplicity sequence of $q \in \bar{E}$ uniquely determines and is determined by the weighted graph of $\pi^{-1}(q)$; or, equivalently, by the weighted graph of Q and the numbers τ, s .

The exceptional divisor Q contracts to a smooth point and has a unique (-1) -curve C . If $Q \neq C$ then the contraction of C leads to a divisor with the same properties. By induction on $\#Q$ it follows that $\beta_Q(C) \leq 2$ and $\beta_Q(G) \leq 3$ for every component G of Q , and if $\beta_Q(G) = 3$ then G meets a twig of Q . Similarly, we see that if we remove from Q the maximal twigs of D_0 contained in Q then what remains is a chain (see Figure 2). Components of this chain are of particular interest, because they are not contracted by ψ . Indeed, $\text{Exc } \psi \wedge D_0$ is the sum of proper transforms of $\text{Exc } \psi_i \wedge D_i$, the latter being contained in the sum of twigs of D_i by Lemma 2.17(d). Here is a list of some elementary properties of Q .

Lemma 2.7 (The geometry of the minimal weak resolution). With the above notation the following hold:

- If $\#Q > 1$ then $T \neq 0$ and $\text{tip}^+(T)$ is the first component of Q .
- If Q is a chain then $B = C$, otherwise B is the first branching component of Q . Every component of $Q - B$ meets at most one twig of D_0 .

- (c) We have $T^0 = C$ if and only if $Q = [(2)_t, 1]$ and $\tilde{C} = 0$, equivalently, if and only if $q \in \bar{E}$ has multiplicity sequence $(\tau)_{t+1}$. If $T^0 \neq C$ then $T^0 \subseteq T$, so $\text{tip}^+(T) = \text{tip}^+(\Delta_T + T^0)$.
- (d) The first blowup over q is (by definition) neither inner nor outer, the next t blowups are outer. If $T^0 \neq C$ then the $(t+2)$ -nd blowup is also outer, and the $(t+3)$ -rd one, if occurs, is the first inner one.

Proof. Parts (a), (b) follow from the inductive structure of Q described above. For the proof of (c), (d) note that after the first $t+1$ blowups over $q \in \bar{E}$ the exceptional divisor, which is an image of $\Delta_T + T^0$, is a chain $[(2)_t, 1]$, so all these blowups (except for the first one) are outer. Because Δ_T is zero or a (-2) -twig, it is not touched by the remaining part of the resolution, so the proper transform of \bar{E} meets this chain only in the last component. If there are no more blowups then $T^0 = C$, so $E_0 \cdot T^0 = \tau$, and since each blowup is outer, each contracted curve meets the image of E_0 with multiplicity τ , so $q \in \bar{E}$ has multiplicity sequence $(\tau)_{t+1}$. On the other hand, if $T^0 \neq C$ then the $(t+2)$ -nd blowup is outer, so $T^0 \subseteq T$ meets Δ_T . This shows (c). Because T^0 is not a part of a (-2) -twig of D_0 , it equals \tilde{C} or is touched at least once more, so the proper transform of \bar{E} meets the exceptional divisor in a common point of the images of T^0 and the next component of Q . It follows that the $(t+3)$ -rd blowup, if occurs, is inner. This shows (d). \square

From now on we denote the cusps of \bar{E} by q_1, \dots, q_c and we write $Q_j, C_j, T_j, t_j, \dots$ for the quantities Q, C, T, t, \dots as above defined for the cusp $q_j \in \bar{E}$, $j \in \{1, \dots, c\}$.

Example 2.8 (Semi-ordinary cusps). A cusp of multiplicity 2 is called *semi-ordinary*. It is locally analytically isomorphic to the singular point of $\{x^2 = y^{2m+3}\}$ at $(0, 0) \in \text{Spec } \mathbb{C}[x, y]$ for some $m \geq 0$. Its multiplicity sequence equals $(2)_{m+1}$. The exceptional divisor of its minimal log resolution is a chain $[(2)_m, 3, 1, 2]$. Hence, $Q = [(2)_m, 1]$, $T = \Delta_T$, $t = m$, $T^0 = B = C$, $T' = 0$, $\tau = 2$ and $s = 1$. A semi-ordinary cusp with $m = 0$ (type A_2) is called *ordinary*.

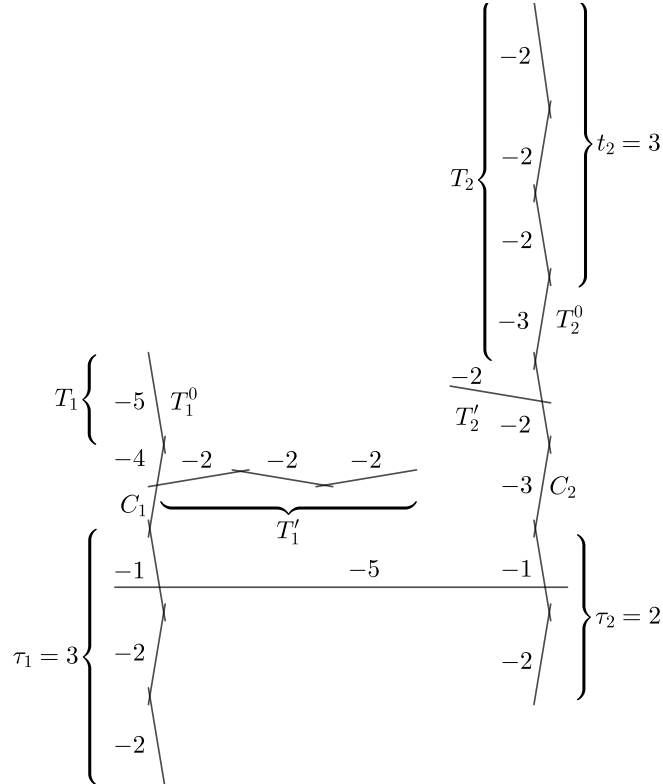

FIGURE 3. The graph of D for a curve of type $\mathcal{H}(5)$

Example 2.9. Let \bar{E} be of type $\mathcal{H}(5)$ (see Definition 1.3). Its cusps have multiplicity sequences $(12, (3)_4)$ and $((4)_4, (2)_3)$, respectively. The divisor D is shown in Figure 3. We have $t_1 = 0$ ($T_1 = [5]$ has no (-2) -twig), $\tau_1 = 3$ and $s_1 = 1$. For the second cusp we have $t_2 = 3$, $\tau_2 = 2$ and $s_2 = 1$. The standard HN-pairs of the cusps of \bar{E} (see [PP17, Section 2D]) are $\binom{15}{12} \binom{3}{1}$ and $\binom{18}{4} \binom{2}{3}$, respectively.

We recall the relation between integers $\deg \bar{E}$ and E^2 in terms of multiplicity sequences of the cusps of \bar{E} . For a cusp $q \in \bar{E}$ we define $M(q)$ as the sum of all terms of the multiplicity sequence of q (including 1's in the end) and $I(q)$ as the sum of their squares.

Lemma 2.10 (Equations for multiplicity sequences). Let $\bar{E} \subseteq \mathbb{P}^2$ be a rational cuspidal curve with cusps $q_1, \dots, q_c \in \bar{E}$. Then

$$\begin{aligned} \text{(a)} \quad & 3 \deg \bar{E} - E^2 - 2 = \sum_{j=1}^c M(q_j), \\ \text{(b)} \quad & (\deg \bar{E})^2 - E^2 = \sum_{j=1}^c I(q_j), \\ \text{(c)} \quad & (\deg \bar{E} - 1)(\deg \bar{E} - 2) = \sum_{i=1}^c (I(q_i) - M(q_i)) \end{aligned}$$

Given multiplicity sequences, these formulas determine $\deg \bar{E}$ and E^2 uniquely provided $\deg \bar{E} \geq 3$, that is, when \bar{E} is singular.

Proof. Let B be a curve on a smooth projective surface Y and let $Y' \rightarrow Y$ be a blowup of a point of multiplicity μ on B . Denote by B' the proper transform of B on Y' . Then

$$K_{Y'} \cdot B' - K_Y \cdot B = \mu \quad \text{and} \quad B^2 - (B')^2 = \mu^2.$$

We have $K_X \cdot E - K_{\mathbb{P}^2} \cdot \bar{E} = -(E^2 + 2) + 3 \deg \bar{E}$ and $\bar{E}^2 - E^2 = (\deg \bar{E})^2 - E^2$, so by induction one gets respectively (a) and (b). Part (c) is their direct consequence.

If two rational cuspidal curves of degrees $d, d' \geq 3$ have the same multiplicity sequences of their cusps then (c) gives $0 = (d-1)(d-2) - (d'-1)(d'-2) = (d-d')(d+d'-3)$. Since $d+d' \neq 3$, it follows that $d = d'$. Thus multiplicity sequences of the cusps of \bar{E} determine uniquely $\deg \bar{E}$, and hence E^2 by (a). \square

Lemma 2.11 (Upper bounds on E^2 , cf. [Ton14], [PP17, Lemma 2.16]).

Assume that $\mathbb{P}^2 \setminus \bar{E}$ is of log general type and has no \mathbb{C}^{**} -fibration. Then:

- (a) if $c = 1$ then $E^2 \leq -3$,
- (b) if $c = 2$ then $E^2 \leq -2$,
- (c) if $c = 2$ and $(\tau_j, s_j) = (2, 1)$ for some $j \in \{1, 2\}$ then $E^2 \leq -3$.

Proof. (a),(b) Suppose the contrary. Let C'_j be the last exceptional curve over $q_j \in \bar{E}$ on the minimal log resolution. Blow up over $C'_1 \cap E$ until the proper transform \hat{E} of E has self-intersection -2 if $c = 1$ and -1 if $c = 2$. Call \hat{C} the exceptional curve of the last blowup, or put $\hat{C} = C'_1$ if no blowups were needed. Then \hat{C} meets some (-2) -curve U which is a non-branching component of the total transform of Q_1 . If $c = 1$ then $|\hat{E} + 2\hat{C} + U|$ induces a \mathbb{P}^1 -fibration which restricts to a \mathbb{C}^1 -, \mathbb{C}^* - or a \mathbb{C}^{**} -fibration of $\mathbb{P}^2 \setminus \bar{E}$. Similarly, if $c = 2$ then so does $|\hat{C} + \hat{E}|$. Since \mathbb{C}^{**} is excluded by assumption, we get $\kappa(\mathbb{P}^2 \setminus \bar{E}) \leq 1$ by Iitaka's Easy Addition Theorem; a contradiction.

(c) We have $E^2 \leq -2$ by (b). Suppose that $E^2 = -2$. The assumption $\tau_j = 2, s_j = 1$ means that C'_j meets a twig $U = [2]$ of D . Then $|E + 2C'_j + U|$ induces a \mathbb{P}^1 -fibration of X which restricts to a \mathbb{C}^{**} -fibration of $\mathbb{P}^2 \setminus \bar{E}$; a contradiction. \square

2D. Almost minimal models with half-integral boundaries.

Given a log surface (X, B) we say that an irreducible curve ℓ is *log exceptional* if $\ell^2 < 0$ and $(K_X + B) \cdot \ell < 0$. The contraction of such curves leads to a model with strong properties given by Mori theory. Below we recall a definition of an *almost log exceptional curve* and the construction of an almost minimal model of the pair $(X_0, \frac{1}{2}D_0)$ given in [Pal19, Definition 3.6], which allows to avoid introducing singularities. The notation introduced here is used also in Sections 2E and 3.

Definition 2.12 (The morphism ψ_A). Let D be a reduced connected divisor on a smooth projective surface X such that $\kappa(X \setminus D) = 2$. Assume that $A \subseteq X$ is a (-1) -curve such that

$$(2.4) \quad A \not\subseteq D, \quad A \cdot D = 2 \quad \text{and} \quad A \text{ meets } D \text{ in two different components,}$$

so A is a superfluous (-1) -curve in $A + D$. For such A we denote by ψ_A the composition of contractions of A and all superfluous (-1) -curves in the subsequent images of D which pass through the image of A .

The morphism ψ_A is well defined, that is, uniquely determined by A . Indeed, if after some number of contractions the image of A is a common point of two superfluous curves in the image of D then it is the only common point of these (-1) -curves, so the linear system of their sum induces a \mathbb{C}^* -fibration of an open subset of $X \setminus D$, contrary to the fact that $\kappa(X \setminus D) = 2$. Therefore, in each step the contracted (-1) -curve is unique.

Note also that since D is connected, the center of each blowup in the decomposition of ψ_A is a common point of two components of the image of D .

We now return to the study of (X_0, D_0) , that is, of the minimal weak resolution of (\mathbb{P}^2, \bar{E}) . Following [Pal19, Section 3] we define inductively a sequence of contractions between smooth projective surfaces

$$(2.5) \quad (X_0, \frac{1}{2}D_0) \xrightarrow{\psi_1} (X_1, \frac{1}{2}D_1) \xrightarrow{\psi_2} \dots \xrightarrow{\psi_n} (X_n, \frac{1}{2}D_n).$$

First, we define inductively the following divisors on X_i . Recall that a *maximal (-2) -twig* is a twig consisting of (-2) -curves which is not properly contained in any other twig consisting of (-2) -curves.

Notation 2.13 ([Pal19, Notation 3.3]). Let (X_i, D_i) be as in (2.5). Assume that X_i is smooth (cf. Lemma 2.17(a)).

- (a) Δ_i is the sum of all maximal (-2) -twigs of D_i .
- (b) Υ_i is the sum of all (-1) -curves U in D_i such that $\beta_{D_i}(U) = 3$ and $U \cdot \Delta_i = 1$ or $\beta_{D_i}(U) = 2$ and U meets exactly one component of D_i (see Figure 4).
- (c) Δ_i^+ is the sum of all (-2) -twigs of D_i meeting Υ_i ; and $\Delta_i^- := \Delta_i - \Delta_i^+$.
- (d) Υ_i^0 is the sum of those components of Υ_i which do not meet Δ_i^+ .
- (e) $R_i = D_i - \Delta_i - \Upsilon_i$.
- (f) E_i is the proper transform of \bar{E} on X_i .
- (g) $D_i^b = D_i - \Upsilon_i - \Delta_i^+ - \text{Bk}_{D_i}(\Delta_i^-)$, see (2.2).

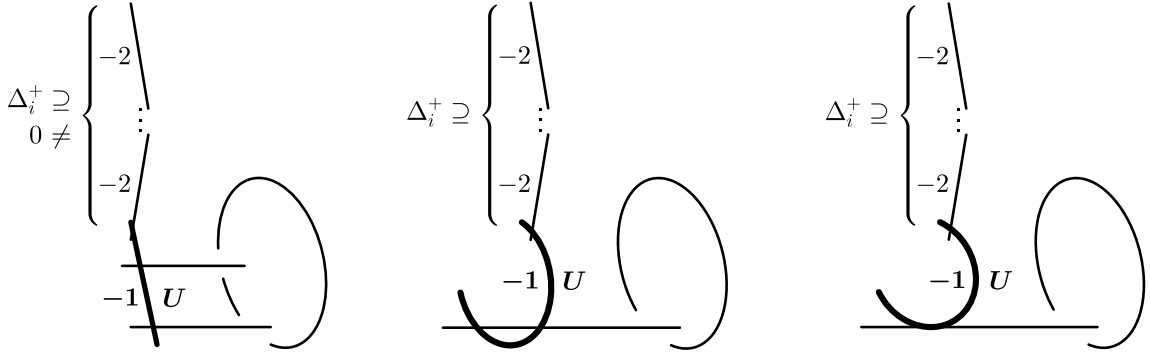

FIGURE 4. Possible arrangements of a component $U \subseteq \Upsilon_i$ inside D_i .

Definition 2.14 (Almost log exceptional curves). A (-1) -curve A on (X_i, D_i) satisfying (2.4) is an *almost log exceptional curve* on $(X_i, \frac{1}{2}D_i)$ if

$$(2.6) \quad A \cdot \Delta_i = 1, \quad A \text{ meets a tip of } \Delta_i \quad \text{and} \quad A \cdot (\Upsilon_i + \Delta_i^+) = 0.$$

Remark (see Figure 5). Let A be almost log exceptional on $(X_i, \frac{1}{2}D_i)$ and let Δ_A be the maximal (-2) -twig of D_i meeting A . If the tip of Δ_A meeting A is not a tip of D_i then $A = \text{Exc } \psi_A$. In the other case, the inclusion $A \subseteq \text{Exc } \psi_A$ is strict unless the component of D_i meeting $\text{tip}^+(\Delta_A)$ meets A , too.

If X_i contains an almost log exceptional curve, say $A_{i+1} \subseteq X_i$, we put

$$\psi_{i+1} = \psi_{A_{i+1}}: X_i \longrightarrow X_{i+1} \quad \text{and} \quad D_{i+1} = (\psi_{i+1})_* D_i.$$

Knowing that X_{i+1} is smooth (see Lemma 2.17(a)), we proceed by induction. The final pair $(X_i, \frac{1}{2}D_i)$, the one with $i = n$, is the first such that there is no almost log exceptional curve on $(X_i, \frac{1}{2}D_i)$. We call $(X_n, \frac{1}{2}D_n)$ an *almost minimal model* of $(X_0, \frac{1}{2}D_0)$ and we put

$$(2.7) \quad \psi := \psi_n \circ \dots \circ \psi_1.$$

We call the number n the *length* of the process (ψ) of almost minimalization. It equals the number of irreducible curves not contained in D_0 contracted by ψ .

 FIGURE 5. Possible arrangements of an almost log exceptional curve A on $(X_i, \frac{1}{2}D_i)$.

Remark. We do not claim that ψ or n is uniquely determined by $(X_0, \frac{1}{2}D_0)$. In general, they depend on the choices of the curves A_i , see Example 2.22. We will simply work with a fixed choice of ψ .

For $(X_i, \frac{1}{2}D_i)$ as above we define the *peeling morphism*

$$(2.8) \quad \alpha_i: (X_i, \frac{1}{2}D_i) \longrightarrow (Y_i, \frac{1}{2}D_{Y_i})$$

where $D_{Y_i} = (\alpha_i)_*D_i$, as the contraction of $\Delta_i + \Upsilon_i$ (it exists by Lemma 2.17(b)).

Remark. The motivation behind Definition 2.14 is [Pal19, Corollary 3.5] which says that there are no log exceptional curves on $(Y_i, \frac{1}{2}D_{Y_i})$ contained in D_{Y_i} and that $A \subseteq X_i$ is almost log exceptional on $(X_i, \frac{1}{2}D_i)$ if and only if $\alpha_i(A)$ is log exceptional on $(Y_i, \frac{1}{2}D_{Y_i})$. In particular, $(X_{\min}, \frac{1}{2}D_{\min}) := (Y_n, \frac{1}{2}D_{Y_n})$ is a minimal model of $(X_0, \frac{1}{2}D_0)$.

As a consequence of basic theorems of the log minimal model program and of the construction of an almost minimal model for $(X_0, \frac{1}{2}D_0)$ in [Pal19, Section 3], we have the following result.

Proposition 2.15 (Properties of minimal models). Let $(X_0, \frac{1}{2}D_0) \xrightarrow{\psi_1} \dots \xrightarrow{\psi_n} (X_n, \frac{1}{2}D_n)$ be some almost minimalization of $(X_0, \frac{1}{2}D_0)$ as defined above and let $\alpha_n: (X_n, \frac{1}{2}D_n) \longrightarrow (X_{\min}, \frac{1}{2}D_{\min})$ be a peeling morphism. Then $\kappa(K_{X_i} + \frac{1}{2}D_i) = \kappa(K_X + \frac{1}{2}D)$ and the following hold:

- (a) If $\kappa(K_X + \frac{1}{2}D) \geq 0$ then $K_{X_{\min}} + \frac{1}{2}D_{\min}$ is numerically effective.
- (b) If $\kappa(K_X + \frac{1}{2}D) = -\infty$ then $X \setminus D$ has a \mathbb{C}^{**} -fibration or $(X_{\min}, \frac{1}{2}D_{\min})$ is a log del Pezzo surface of Picard rank one, that is, $-(K_{X_{\min}} + \frac{1}{2}D_{\min})$ is ample and $\rho(X_{\min}) = 1$.

Remark 2.16 (The shape of $\Upsilon_0 + \Delta_0^+$).

- (a) Let us note that $E_i \subseteq R_i$. This fact is implicitly used in the proof of [Pal19, Theorem 4.5(6)] (in the form of the equality $c'_0 = \#\Upsilon_0^0$). Let us give a proof. Clearly $E_i \not\subseteq \Delta_i$ because E_0 , and hence each E_i for $i \in \{1, \dots, n\}$, is not contained in any twig of D_i . Suppose that $E_i \subseteq \Upsilon_i$. Then, since $\beta_{D_0}(E_0) = \sum_{j=1}^c (\tau_j + 1 - s_j) \geq 2$, we get $E_0 \subseteq \Upsilon_0$, so $(c, \tau_1, s_1) = (1, 2, 1)$, that is, the multiplicity sequence of the unique cusp $q_1 \in \bar{E}$ consists of even terms followed by $(1, 1)$ at the end, and $E_0^2 = -1$, so $E^2 = -3$. Then Lemma 2.10(b) gives $(\deg E)^2 \equiv 3 \pmod{4}$; a contradiction.
- (b) By (a), $\Upsilon_0 \subseteq C_1 + \dots + C_c$, so it is easy to see that the divisor $\Upsilon_0 + \Delta_0^+$ equals the sum of exceptional divisors over the semi-ordinary cusps of \bar{E} (see Example 2.8). By Definition 2.14 its push-forward on X_i does not meet almost log exceptional curves. Consequently, if all cusps of \bar{E} are semi-ordinary then $n = 0$, that is, $(X_0, \frac{1}{2}D_0)$ is already almost minimal.

Lemma 2.17 (Properties of $(X_i, \frac{1}{2}D_i)$, [Pal19]). Let (X_i, D_i) be as above. Then

- (a) X_i is smooth, E_i is smooth and $D_i - E_i$ is snc.
- (b) The components of Υ_i are disjoint.
- (c) $\alpha_i^*(K_{Y_i} + \frac{1}{2}D_{Y_i}) = K_{X_i} + \frac{1}{2}D_i^b$.
- (d) $\text{Exc } \psi_i$ is a chain and $\text{Exc } \psi_i - A_i$ is contained in (at most two) maximal twigs of D_{i-1} .
- (e) The point $\psi_i(A_i)$ is a point of normal crossings of two components of D_i . The set $\text{Supp } D_i \setminus \psi_i(A_i)$ is connected.
- (f) $(\psi_i)_*(\Upsilon_{i-1}) \subseteq \Upsilon_i$ and $(\psi_i)_*(\Delta_{i-1}^+) \subseteq \Delta_i^+$.
- (g) The morphism ψ_i does not touch the proper transforms of the twigs of D_i . In particular, $(\psi_i^{-1})_*\Delta_i \subseteq \Delta_{i-1}$ and $(\psi_i^{-1})_*\Delta_i^- \subseteq \Delta_{i-1}^-$.
- (h) $(\psi_i^{-1})_*R_i \subseteq R_{i-1}$.

Proof. Parts (a),(b) and (c) are proved in [Pal19, Proposition 4.1(i) and Lemma 3.4(i)]. Parts (d) and (e) follow from the fact that D_{i-1} is connected and $A_i \cdot D_{i-1} = 2$, so A_i lies in a circular subdivisor of $D_{i-1} + A_i$, and ψ_i contracts superfluous (-1) -curves, which are non-branching in the images of $D_{i-1} + A_i$. By [Pal19, Proposition 4.1(iii)] $(\psi_i)_*(\Upsilon_{i-1}) \subseteq \Upsilon_i$, so Υ_{i-1} is not touched by ψ_i . Then Δ_{i-1}^+ is not touched by ψ_i , because $A_i \cdot \Delta_{i-1}^+ = 0$. This gives (f). Part (g) is a direct consequence of (e) and (f).

For the proof of (h) let G be a component of D_{i-1} such that $G \not\subseteq \text{Exc } \psi_i$ and $\psi_i(G) \subseteq R_i$. By (f), G is not a component of Υ_{i-1} . Suppose that it is contained in some (-2) -twig Δ_G of D_{i-1} . The morphism ψ_i touches but does not contract G , so A_i meets Δ_G . There is no component of $D_{i-1} - \Delta_G$ meeting both G and A_i , because otherwise we get $\psi_i(G) \subseteq \Upsilon_i$, contrary to the assumption. It follows that A_i meets G . But then either ψ_i contracts G or again $\psi_i(G) \subseteq \Upsilon_i$; a contradiction. \square

2E. Consequences of non-existence of a \mathbb{C}^{**} -fibration.

As before, assume $\bar{E} \subseteq \mathbb{P}^2$ is a rational cuspidal curve for which Negativity Conjecture 1.1 holds. Let $\pi: (X, D) \rightarrow (\mathbb{P}^2, \bar{E})$ and $\pi_0: (X_0, D_0) \rightarrow (\mathbb{P}^2, \bar{E})$ denote respectively the minimal log resolution and the minimal weak resolution. We have $\kappa(K_X + \frac{1}{2}D) = \kappa(K_{X_0} + \frac{1}{2}D_0)$ by Proposition 2.15. As discussed above, by the existing classification results we may reformulate our assumptions as:

$$(2.9) \quad \begin{array}{l} \bar{E} \subseteq \mathbb{P}^2 \text{ is a rational cuspidal curve such that } \kappa(\mathbb{P}^2 \setminus \bar{E}) = 2, \kappa(K_{X_0} + \frac{1}{2}D_0) = -\infty \text{ and} \\ \mathbb{P}^2 \setminus \bar{E} \text{ has no } \mathbb{C}^{**}\text{-fibration} \end{array}$$

By Proposition 2.15(b), $(X_{\min}, \frac{1}{2}D_{\min})$ is a log del Pezzo surface of Picard rank 1, hence the number $(2K_{X_{\min}} + D_{\min})^2$ is positive. This number is computed in [Pal19, Lemma 4.4] and it is shown in Theorem 4.5(6) loc. cit. that its positivity bounds the number of components of D_n . The explicit formula for this bound is important for us. It can be conveniently formulated in terms of contributions λ_j , $j \in \{1, \dots, c\}$ of cusps, see (2.12), which we define as (see Notation 2.6 and 2.13):

$$(2.10) \quad \lambda_j = \tau_j - s_j + \#(\psi_*Q_j - \psi_*Q_j \wedge \Upsilon_n^0) - b_0(\psi_*Q_j \wedge \Delta_n).$$

Remark 2.18 (Properties of λ_j). The following hold:

(a) If $q_j \in \bar{E}$ is not ordinary, then

$$(2.11) \quad \lambda_j \geq \tau_j - s_j + 1 \geq \tau_j \geq 2.$$

(b) If $q_j \in \bar{E}$ is semi-ordinary then $\lambda_j = 1 + t_j$. In particular, $\lambda_j = 1$ if and only if $q_j \in \bar{E}$ is ordinary.

(c) If $q_j \in \bar{E}$ is not ordinary and ψ does not touch Q_j then $\lambda_j = \tau_j - s_j + \#Q_j - b_0(Q_j \wedge \Delta_0)$.

Proof. (a) Assume that q_j is not an ordinary cusp. Then $\psi(C_j) \not\subseteq \Upsilon_n^0 + \Delta_n$, so $\#(\psi_*Q_j - \psi_*Q_j \wedge (\Upsilon_n^0 + \Delta_n)) \geq 1$ and hence $\lambda_j \geq \tau_j - s_j + 1$, which proves (2.11) since $s_j \leq 1$ and $\tau_j \geq 2$ by definition.

(b) Assume now that $q_j \in \bar{E}$ is a semi-ordinary cusp, that is, $(\tau_j, s_j) = (2, 1)$ and $Q_j = [(2)_{t_j}, 1]$ (see Example 2.8). By Remark 2.16(b), ψ does not touch Q_j , so $\#\psi_*Q_j = t_j + 1$. Moreover, if $t_j = 0$ then we have $\psi_*Q_j \wedge \Upsilon_n^0 = \psi(C_j)$ and $b_0(\psi_*Q_j \wedge \Delta_n) = 0$; otherwise $\psi_*Q_j \wedge \Upsilon_n^0 = 0$ and $b_0(\psi_*Q_j \wedge \Delta_n) = 1$.

(c) If ψ does not touch Q_j then by Lemma 2.17(f), $\psi_*Q_j \wedge \Delta_n = \psi_*(Q_j \wedge \Delta_0)$ and $\psi_*Q_j \wedge \Upsilon_n^0 = \psi_*(Q_j \wedge \Upsilon_0^0)$. The latter divisor is zero if $q_j \in \bar{E}$ is not ordinary. \square

Lemma 2.19 (The basic inequality). Let the assumptions be as in (2.9). Then

$$(2.12) \quad \lambda_1 + \dots + \lambda_c \leq 6.$$

Proof. By Lemma 2.17(c), we have $0 < (2K_{X_{\min}} + D_{X_{\min}})^2 = (2K_{X_n} + D_n^b)^2$. Let $(X'_n, D'_n) \rightarrow (X_n, D_n)$ be the minimal log resolution of (X_n, D_n) . By [Pal19, Lemma 4.4]:

$$(2K_{X_n} + D_n^b)^2 = 3h^0(2K_X + D) + 8 + b_0(\Delta'_n) + \#\Upsilon_n^0 - \rho(X'_n) - n - \sum_T \frac{1}{d(T)},$$

where the last sum runs over all connected components T of Δ_n^- and Δ'_n is the sum of the (-2) -twigs of D'_n . Lemma 2.17(e) implies that ψ is an isomorphism near the non-nc points of D_0 , so $(X'_n, D'_n) \rightarrow (X_n, D_n)$ resolves the tangency points of E_n and ψ_*C_j . The exceptional divisor over such point contains τ_j components and s_j maximal (-2) -twigs of D'_n (see Section 2C). Thus $b_0(\Delta'_n) = b_0(\Delta_n) + \sum_{j=1}^c s_j$ and $\rho(X'_n) + n = \#D'_n = 1 + \sum_{j=1}^c (\tau_j + \#\psi(Q_j))$. Therefore,

$$0 < (2K_{X_{\min}} + D_{X_{\min}})^2 = 3h^0(2K_X + D) + 7 - \sum_{j=1}^c \lambda_j - \sum_T \frac{1}{d(T)} \leq 3h^0(2K_X + D) + 7 - \sum_{j=1}^c \lambda_j.$$

Eventually, $h^0(2K_X + D) = 0$ by our assumptions, so (2.12) follows. \square

Lemma 2.20 (Pullbacks of almost log exceptional curves). Let X_k , $k \in \{0, \dots, n-1\}$ be one of the surfaces in Proposition 2.15. For $i \geq k+1$ denote by A'_i the proper transform of A_i on X_k . Then

- (a) A'_i is almost log exceptional on $(X_k, \frac{1}{2}D_k)$.
- (b) Total transforms on X_k of the divisors $\text{Exc } \psi_i$, $i \geq k+1$ are equal to their proper transforms, hence are pairwise disjoint.
- (c) If (2.9) holds then the proper transform of $\text{Exc } \psi_i$ on X_k equals $\text{Exc } \psi_{A'_i}$.

Proof. By induction we may assume $i = k+2$. Put $A = A'_{k+2} \subseteq X_k$.

(a) Lemma 2.17(e) implies that A_{k+2} does not pass through $\psi_{k+1}(A_{k+1})$, so ψ_{k+1} does not touch A . It follows that A is as in (2.4). Let $W \subseteq \Delta_{k+1}^-$ be the maximal (-2) -twig of D_{k+1} meeting A_{k+2} and let $W' = (\psi_{k+1}^{-1})_*W$. By Lemma 2.17(f),(g)

$$(2.13) \quad A \cdot (\Upsilon_k + \Delta_k^+) \leq A_{k+2} \cdot (\Upsilon_{k+1} + \Delta_{k+1}^+) = 0 \quad \text{and} \quad A \cdot \Delta_k \geq A \cdot W' = 1.$$

Suppose that (a) fails. Suppose further that W' is not a maximal (-2) -twig. Then there is a component $W'_0 \subseteq \Delta_k$ meeting W' , such that $\psi_{k+1}(W'_0) \not\subseteq \Delta_{k+1}$. By Lemma 2.17(d) it follows that A_{k+1} meets W'_0 and hence $\text{Exc } \psi_{k+1} = A_{k+1}$. But then $\psi_{k+1}(W'_0) \subseteq \Upsilon_{k+1}$ and $W \subseteq \Delta_{k+1}^+$; a contradiction. Thus W' is a maximal (-2) -twig of D_k . Since (a) fails, we have $A \cdot \Delta_k \geq 2$ by (2.13). Then A meets a different maximal (-2) -twig $W'' \subseteq D_k$. Since A_{k+2} is almost log exceptional, $(\psi_{k+1})_*(W'')$ is not a (-2) -twig. Then A_{k+1} meets W'' . Since ψ_{k+1} does not touch A , it does not contract the component of W'' meeting A , hence the latter becomes necessarily a component of Υ_{k+2} . But then A_{k+2} is not almost log exceptional; a contradiction.

(b), (c) By Lemma 2.17(d) $\text{Exc } \psi_{k+2} - A_{k+2}$ is contained in the sum of twigs of D_{k+1} , so by Lemma 2.17(e) it does not pass through the image of A_{k+1} . Consequently, the proper and the total transforms of $\text{Exc } \psi_{k+2}$ on X_k are equal. Denote them by T . The self-intersection and branching numbers of the components of $\text{Exc } \psi_{k+2}$ and of their proper transforms are the same, so $T \subseteq \text{Exc } \psi_A$. Suppose that the inclusion is proper and let σ be the contraction of T (it is a part of ψ_A). Then there is a component V of $\text{Exc } \psi_A - T$ such that $\sigma(V)$ is a superfluous (-1) -curve in σ_*D_k and the chain $\sigma_*(\text{Exc } \psi_{k+1})$ meets V . Now contract the (-1) -curves in the subsequent images of $\sigma_*(\text{Exc } \psi_{k+1})$ until the image of $\sigma(V)$, say V' , becomes a 0-curve. The branching number of V' in the image of D_k equals at most $\beta_{\sigma_*(D_k+A_{k+1})}(\sigma_*V) \leq \beta_{\sigma_*D_k}(\sigma_*V) + 1 \leq 3$. Thus $|V'|$ induces a \mathbb{P}^1 -fibration which restricts to a \mathbb{C}^{**} -fibration of some open subset of $\mathbb{P}^2 \setminus \bar{E}$; a contradiction with (2.9). \square

Remark 2.21 (Changing the process of almost minimalization). Lemma 2.20(c) implies that given a process of almost minimalization ψ of $(X_0, \frac{1}{2}D_0)$ as above and two almost log exceptional curves A_i, A_j , $j > i$ in this process, there exist another process of almost minimalization ψ which agrees with ψ until it reaches X_{i-1} but at the i -th step contracts A , the proper transform of A_j , instead of A_i , and moreover that the respective $\text{Exc } \psi_A$ is the proper transform of $\text{Exc } \psi_j$. However, after such reordering it may happen that the push-forward of A_i on X_i is no longer almost log exceptional (hence at the end we may get a non-isomorphic almost minimal model). Therefore, we cannot freely change the order of contractions of almost log exceptional curves. This is illustrated by the example below.

Example 2.22 (Non-uniqueness of almost minimal models). Let us look at a curve of type $\mathcal{J}(2)$ (the situation for other $\mathcal{J}(k)$ is similar, see Propositions 3.16–3.17). It is constructed in Section 4D. Figure 6 illustrates two possible courses $(\psi_3 \circ \psi_2 \circ \psi_1$ and $\tilde{\psi}_2 \circ \psi_1)$ of the almost MMP for the pair $(X_0, \frac{1}{2}D_0)$.

First, we find relevant almost log exceptional curves as in Figure 6. For $j \in \{1, 2\}$ denote by V_j, W_j respectively the (-3) -curve and the (-2) -curve meeting C_j , and denote the first and the last tip of the long (-2) -twig of Q_1 by U_1 and U_2 , respectively. Let L be the proper transform on X_0 of the line ℓ tangent to \bar{E} at q_1 . The multiplicity sequence of q_1 is $(4, 4, 4, 2, 2)$, hence the inequality $4 < (\ell \cdot \bar{E})_{q_1} \leq \deg \bar{E} = 9$ implies that $(\ell \cdot \bar{E})_{q_1} = 8$, so by the projection formula $L \cdot U_2 = 1$ and $\ell \cdot \bar{E} - (\ell \cdot \bar{E})_{q_1} = 1$. It follows that $L \cdot (D_0 - U_2) = 1 = L \cdot E_0$. We now show the existence of (-1) -curves L_j , $j \in \{1, 2\}$ satisfying $L_j \cdot D_0 = 2$ and meeting D_0 on W_j and V_{3-j} . To this end, let $\eta: X_0 \rightarrow \tilde{X}_0$ be the contraction of $L + (D_0 - E_0 - V_1)$. Then $\rho(\tilde{X}_0) = 1$, so $\tilde{X}_0 \cong \mathbb{P}^2$ and $\eta(E_0)$ is a cuspidal curve with cusps p_1, p_2 whose multiplicity sequences are $(2, 2)$ and $(4, 2, 2)$, respectively. Moreover, $\eta(V_1)$ is a line meeting $\eta(E_0)$ at $\eta(L)$ with multiplicity 2 and at p_1 with multiplicity 4. Thus $\deg \eta(E_0) = 6$. Let ℓ_2 be the line tangent to $\eta(E_0)$ at p_2 . Then $\ell_2 \cdot \eta(E_0) = 6$, so ℓ_2 does not meet $\eta(E_0)$ in any other point and meets the line $\eta(V_1)$ off $\eta(E_0)$. Let ℓ_1 be the line joining the two cusps of $\eta(E_0)$. Then $6 = \ell_1 \cdot \eta(E_0) \geq (\ell_1 \cdot \eta(E_0))_{p_1} + (\ell_1 \cdot \eta(E_0))_{p_2} \geq 2 + 4 = 6$, so ℓ_1 meets $\eta(E_0)$ only at p_1, p_2 with multiplicities 2 and 4. It follows that the proper transforms L_1, L_2 of ℓ_1, ℓ_2 are as claimed.

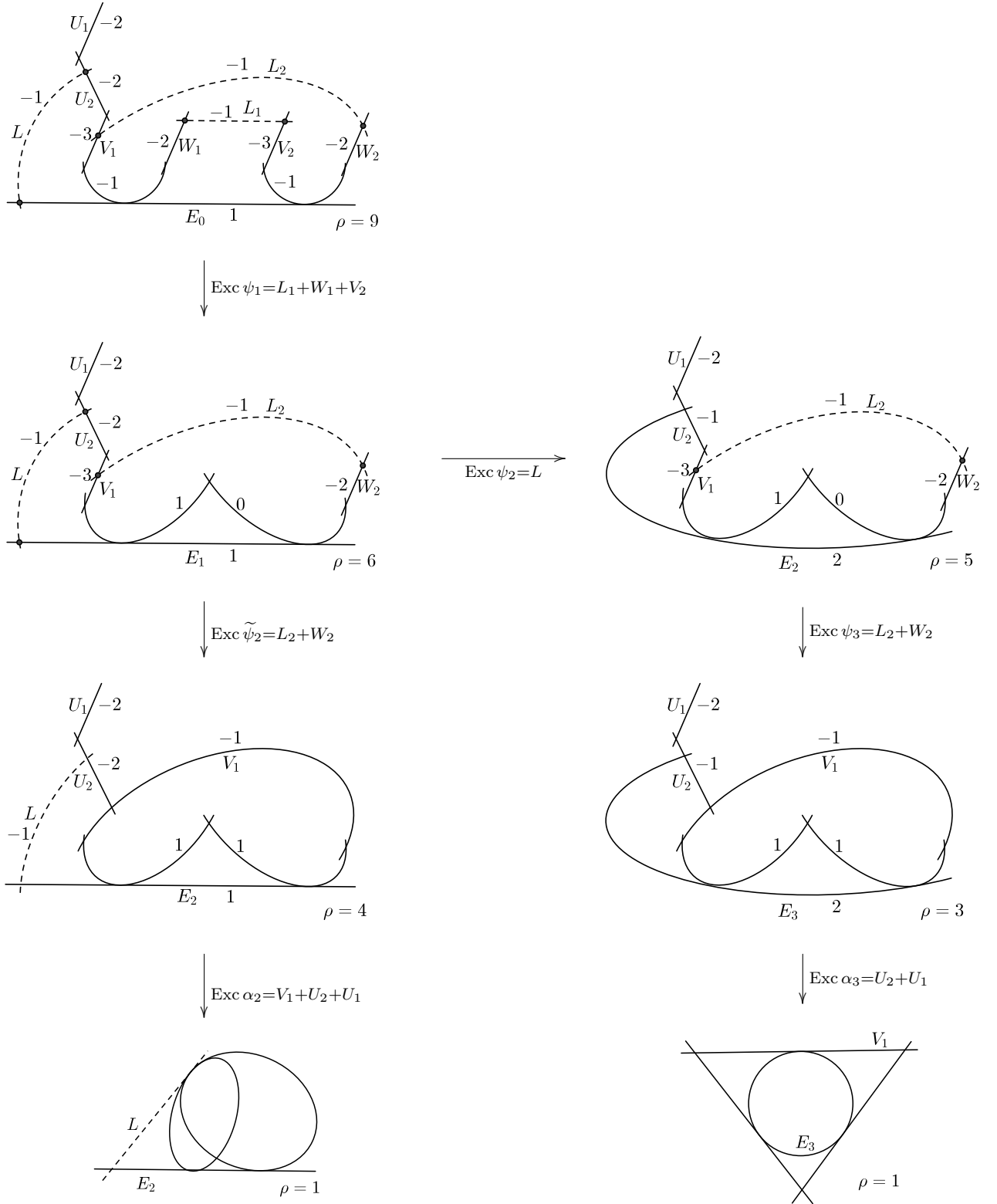
 FIGURE 6. Two minimal models of $(X_0, \frac{1}{2}D_0)$ for $\bar{E} \subseteq \mathbb{P}^2$ of type $\mathcal{J}(2)$.

As the first step of the construction of an almost minimal model we take $A_1 := L_1$, then $\text{Exc } \psi_1 = W_1 + L_1 + V_2$ and the images of L, L_2 are both almost log exceptional on $(X_1, \frac{1}{2}D_1)$. Now we have a choice: we can either take $A_2 := \psi_1(L)$ or $A_2 := \psi_1(L_2)$. To emphasize that, we denote ψ_2 by $\tilde{\psi}_2$ in the second case.

Consider the first choice. Then $\text{Exc } \psi_2 = \psi_1(L)$ and the image of L_2 is almost log exceptional on $(X_2, \frac{1}{2}D_2)$. We then take $A_3 := (\psi_2 \circ \psi_1)(L_2)$, so $\text{Exc } \psi_3 = (\psi_2 \circ \psi_1)_*(L_2 + W_2)$. Now $\Delta_3^- = 0$, so

Lemma 3.2 (Properties of R_n).

- (a) Every component of $\Upsilon_n - \psi_*\Upsilon_0$ meets R_n in two points, exactly one of which is a center of ψ .
- (b) $\psi_*^{-1}R_n$ is a connected subdivisor of R_0 .
- (c) $\#R_n = \#D_{\min} = n + 1$.
- (d) Any two distinct components of D_{\min} meet.
- (e) For each component G of $D_0 - E_0$ we have $\psi^+(G) \cdot \psi^+(E_0) \leq G \cdot E_0 + 1$. If the equality holds then the unique connected component of $\text{Exc } \psi^+$ meeting G and E_0 is a chain equal to $A + \Delta_A$, where Δ_A is a maximal (-2) -twig of D_0 meeting G and A is an almost log exceptional curve meeting E_0 , see Figure 7.



FIGURE 7. The preimage on X_0 of a center of ψ^+ on E_n (Lemma 3.2(e)).

- (f) Every component of $\psi_*^{-1}R_n - E_0$ meets $E_0 + \Delta_0 - \psi_*^{-1}\Delta_n$.
- (g) The centers of ψ^+ are the semi-ordinary cusps of $\psi^+(E_0)$ and the images of A_1, \dots, A_n . At each of the latter points exactly two analytic branches of D_{\min} meet.
- (h) $n = 0$ if and only if all cusps of \bar{E} are semi-ordinary.

Proof. (a) Let U be a component of $\psi_*^{-1}\Upsilon_n - \Upsilon_0$. Because $U \not\subseteq \Upsilon_0$, the morphism ψ touches U , so $\psi(U)$ contains a center of ψ . By Lemma 2.17(b),(g), this center is not contained in $\Delta_n + (\Upsilon_n - \psi(U))$, so by Lemma 2.17(e) it is a point of normal crossings of $\psi(U)$ and R_n . We have $\psi(U) \cdot R_n = 2$ by the definition of Υ_n and by Lemma 2.17(b), so $\psi(U)$ meets R_n in exactly two points. Moreover, one of these points is not a center of ψ , for otherwise by Lemma 2.17(e) D_0 would not be connected.

(b) Lemma 2.17(e) implies that $\psi_*^{-1}D_n$ is connected. By Lemma 2.17(g) $\psi_*^{-1}\Delta_n$ is contained in the sum of twigs of $\psi_*^{-1}D_n$, hence $\psi_*^{-1}(D_n - \Delta_n) = \psi_*^{-1}(R_n + \Upsilon_n)$ is connected. Let $U \subseteq X_0$ be a proper transform of a component of Υ_n . If $U \subseteq \Upsilon_0$ then U is the unique (-1) -curve over a semi-ordinary cusp (see Remark 2.16), and if $U \not\subseteq \Upsilon_0$ then $U \cdot \psi_*^{-1}R_n = 1$ by (a). In any case, U meets $\psi_*^{-1}(D_n - \Delta_n)$ in one point, so $\psi_*^{-1}(D_n - \Delta_n) - U$ is connected. Thus $\psi_*^{-1}R_n = \psi_*^{-1}(D_n - \Delta_n - \Upsilon_n)$ is connected and $\psi_*^{-1}R_n \subseteq R_0$ by Lemma 2.17(h).

(c) The minimal model $(X_{\min}, \frac{1}{2}D_{\min})$ of $(X_0, \frac{1}{2}D_0)$ is a log del Pezzo surface of Picard rank one. Hence,

$$\#D_{\min} - 1 = \#D_{\min} - \rho(X_{\min}) = \#D_0 - \rho(X_0) + n = \#\bar{E} - \rho(\mathbb{P}^2) + n = n.$$

Recall that R_n is the proper transform of D_{\min} on X_n (see Proposition 2.15). Therefore, $\#R_n = \#D_{\min} = n + 1$, as claimed.

(d) Because $\rho(X_{\min}) = 1$, every curve on X_{\min} is numerically equivalent to a positive multiple of an ample divisor on X_{\min} , hence every two distinct curves on X_{\min} have a positive intersection number.

(e) If $G \cdot E_0 < \psi(G) \cdot E_n$ then we are done by [Pal19, Lemma 4.1(vii)] and Lemma 2.20(a), so assume $G \cdot E_0 = \psi(G) \cdot E_n < \psi^+(G) \cdot \alpha_n(E_n)$. Then $\psi(G)$ meets a component $U \subseteq \Upsilon_n - \psi_*\Upsilon_0$ for which $U \cdot E_n > 0$. The former implies that $\psi_*^{-1}U \cdot E_0 = 0$, so we are done by applying [Pal19, Lemma 4.1(vii)] to U .

(f) This follows immediately from (d) and (e).

(g) This follows from Lemma 2.17(d) and from the definition of Υ_n (see Figure 4 and Remark 2.16).

(h) If \bar{E} has only semi-ordinary cusps then $\Delta_0^- = 0$, so there is no almost log exceptional curve on $(X_0, \frac{1}{2}D_0)$ (see (2.6)), hence $n = 0$. Conversely, if $n = 0$ then (c) gives $\#R_0 = 1$, so $R_0 = E_0$. Then $C_1, \dots, C_c \subseteq \Upsilon_0$, so q_1, \dots, q_c are semi-ordinary. \square

The following lemma is a step towards Lemma 3.5. For the definition of T_j, T_j^0 and T_j' see Notation 2.6(f),(h) and (i), respectively.

Lemma 3.3 (A restriction on loops in $A_i + Q_j$). If a proper transform A of some $A_i, i \in \{1, \dots, n\}$ meets $\text{tip}^+(T_j)$ for some $j \in \{1, \dots, n\}$ then $A \cdot (T_j^0 + \text{tip}^+(T_j')) = 0$.

Proof. We may assume $j = 1$. By Lemma 2.20(a) A is an almost log exceptional curve on $(X_0, \frac{1}{2}D_0)$. Since A meets $\text{tip}^+(T_1)$, we have $T_1 \neq 0$, $A \cdot \text{tip}^+(T_1) = 1$ and $A \cdot (D_0 - \text{tip}^+(T_1)) = 1$ by (2.6). Suppose that A meets $T_1^0 + \text{tip}^+(T_1')$. Let P be the circular subdivisor of $D_0 + A$ and let V be the component of P meeting $D_0 + A - P$, see Figure 8. Because $D_n - R_n$ is a sum of disjoint chains, ψ_*P contains a component of R_n . Hence, $V \subseteq \psi_*^{-1}R_n$ by Lemma 3.2(b). The only possible (-2) -twig of D_0 meeting V , namely Δ_{T_1} (see Notation 2.6(g)), is contained in P , so by Lemma 3.2(d),(e), $V \cdot E_0 = \psi^+(V) \cdot \psi^+(E_0) > 0$. Hence, V equals C_1 or \tilde{C}_1 .

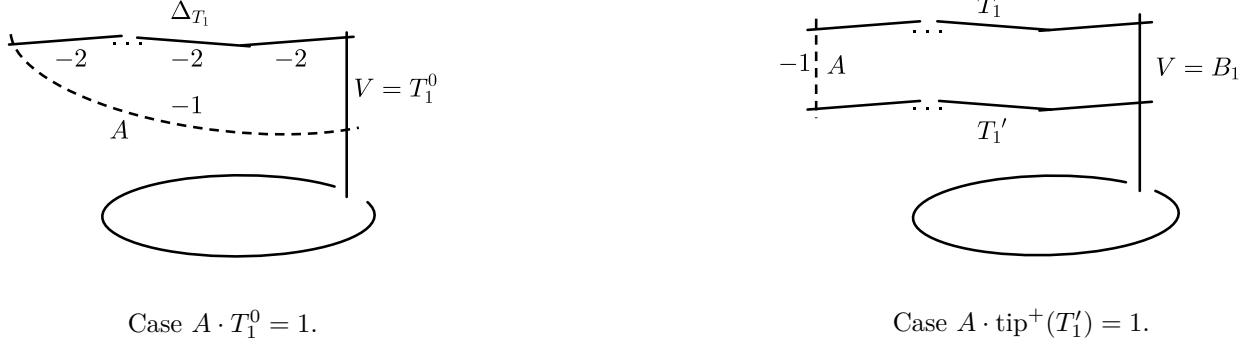

FIGURE 8. The curve A from the proof of Lemma 3.3.

Consider the case $V = C_1$. Since C_1 is non-branching in Q_1 , Lemma 2.7(b),(c) gives $Q_1 = P - A$. Let σ be the contraction of $P - C_1 + (Q_2 + \cdots + Q_c)$. The image of X_0 is a smooth surface of Picard rank one, so it is isomorphic to \mathbb{P}^2 . The image of C_1 has one singular point, which is an ordinary double point, so $\sigma(C_1)$ is a nodal cubic, and $\sigma(C_1) \cdot \sigma(E_0) = C_1 \cdot E_0 = \tau_1$. Hence, $3 \deg \sigma(E_0) = \tau_1$. We have $\tau_1 \leq \lambda_1 \leq 6$ by (2.12), so $\deg \sigma(E_0) \leq 2$. In particular, $\sigma(E_0)$ is smooth, so $c = 1$. Moreover, σ does not touch E_0 , so

$$E^2 = E_0^2 - \tau_1 = \sigma(E_0)^2 - \tau_1 = (\deg \sigma(E_0))^2 - 3 \deg \sigma(E_0) = -2,$$

a contradiction with Lemma 2.11(a).

Consider the case $V = \tilde{C}_1$. By the definition of T_1^0 the components of $P - A$ are the last components of Q_1 contracted by π_0 , so $Q_1 = (P - A) + C_1 + \Delta_{C_1}$, where Δ_{C_1} is zero or a (-2) -twig of D_0 meeting C_1 , say $\Delta_{C_1} = [(2)_{r-1}]$ for some $r \geq 1$. Let σ be the contraction of $(P - \tilde{C}_1) + (C_1 + \Delta_{C_1}) + (Q_2 + \cdots + Q_c)$. As in the previous case, we see that $\sigma(X_0) \cong \mathbb{P}^2$ and $\sigma(\tilde{C}_1)$ is a nodal cubic. The curve $\sigma(E_0)$ has a cusp with multiplicity sequence $((\tau_1)_r)$ at $\sigma(C_1)$, so $3 \deg \sigma(E_0) = \sigma(\tilde{C}_1) \cdot \sigma(C_1) = \tau_1 r + 1$. Note that ψ_*Q_1 contains $\psi(C_1) + \psi(\tilde{C}_1)$, so

$$\#\psi_*Q_1 - b_0(\Delta_n \wedge \psi_*Q_1) - \#\Upsilon_n^0 \wedge \psi_*Q_1 \geq 2.$$

We have $s_1 = 0$ (see Notation 2.6(d)), so $\lambda_1 \geq \tau_1 + 2$. Thus $\tau_1 \leq \lambda_1 - 2 \leq 4$ by (2.12). It follows that $3 \deg \sigma(E_0) \leq 4r + 1$. Because $\sigma(E_0)$ is singular, we have $\deg \sigma(E_0) \geq 3$, so $r \geq 2$. The intersection multiplicity of a cusp with its tangent line equals the sum of some initial terms of its multiplicity sequence, so in our case $2\tau_1 \leq \deg \sigma(E_0)$. Thus $6\tau_1 \leq 3 \deg \sigma(E_0) = \tau_1 r + 1$, which gives $r \geq 6$. It follows that ψ contracts some components of Δ_{C_1} : indeed, otherwise

$$\#\psi_*Q_1 - b_0(\Delta_n \wedge \psi_*Q_1) - \#\Upsilon_n^0 \wedge \psi_*Q_1 \geq \#(C_1 + \tilde{C}_1 + \Delta_{C_1}) - 1 \geq 6,$$

so $\lambda_1 \geq \tau_1 + 6 \geq 8$, contrary to (2.12). Thus there exists another almost log exceptional curve $A_{i'}$, $i' \neq i$, whose proper transform $A' \subseteq X_0$ meets $\text{tip}^+(\Delta_{C_1})$. Lemma 2.20 implies that A' meets D_0 in $\text{tip}^+(\Delta_{C_1})$ and in

$$D_0 - \Delta_{C_1} - (\text{Exc } \psi_A - A) = (C_1 + \tilde{C}_1) + (E_0 + Q_2 + \cdots + Q_c).$$

It follows that A' meets $C_1 + \tilde{C}_1$: indeed, otherwise $1 = \sigma(\tilde{C}_1) \cdot \sigma(A') = 3 \deg \sigma(A')$, which is impossible. Let σ' be the contraction of $P - \tilde{C}_1 + (A' + \Delta_{C_1}) + (Q_2 + \cdots + Q_c)$. Again, $\sigma'(X_0) \cong \mathbb{P}^2$ and $\sigma'(\tilde{C}_1)$ is a nodal cubic. The curve A' meets C_1 , because otherwise A' meets \tilde{C}_1 and $\sigma'(C_1)^2 = C_1^2 + 1 = 0$, which is impossible. Hence, $\sigma'(C_1)$ is also a nodal cubic, so $9 = \sigma'(C_1) \cdot \sigma'(\tilde{C}_1) = C_1 \cdot \tilde{C}_1 = 1$; a contradiction. \square

Remark 3.4 (Orevkov curves). The proof of Lemma 3.3 uses the assumption (2.9) that $\mathbb{P}^2 \setminus \bar{E}$ has no \mathbb{C}^{**} -fibration, which is necessary and was used to restrict the shape of $T_1 + T_1'$. To see the necessity of this assumption let $\bar{E} \subseteq \mathbb{P}^2$ be the Orevkov curve $\mathcal{OR}_1(k)$ or $\mathcal{OR}_2(k)$ (originally, in [Ore02] denoted by C_{4k}, C_{4k}^*). The minimal weak resolution of such curve is shown in Figure 9, cf. Figures 20–21 in [PP17].

The existence of an almost log exceptional curve A meeting $\text{tip}^+(T_1)$ and $T_1^0 + \text{tip}^+(T_1')$, see Figure 9, is shown, for example, in [Ton12b, Lemma 15] (see [PP17, Example 3.2] for the case $k = 0$). Here, the twigs T_1, T_1' are complicated (in particular can be arbitrarily long) and $\psi = \psi_A$ contracts them.

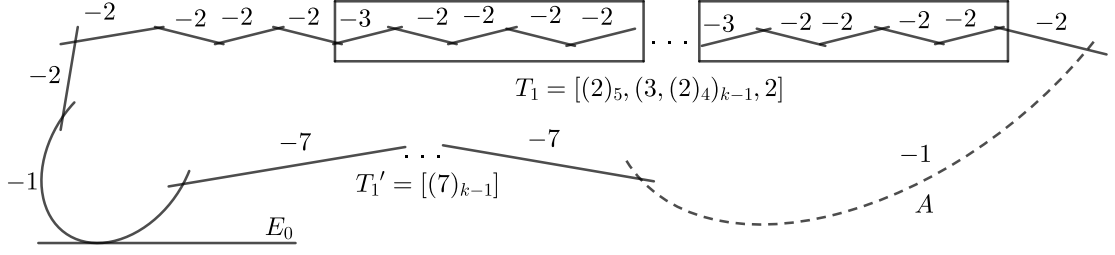

FIGURE 9. An almost log exceptional curve A excluded by Lemma 3.3.

The following lemma will be used to show the existence of a line $\ell \subseteq \mathbb{P}^2$ as in Theorem 1.4. Note that by Lemma 2.7(c) $T_j \in \Delta_{T_j}$ (see Notation 2.6(g)) if and only if $Q_j = [2, \dots, 2, 1]$ and $\tilde{C}_j = 0$, equivalently if and only if $T_j^0 = C_j$. Note also that if T_j is zero or a twig of D_0 then $\tilde{C}_j \not\subseteq T_j$, so then the condition $\tilde{C}_j = 0$ in the latter equivalence can be omitted.

Lemma 3.5 (Some almost log exceptional curves give special lines). Let (μ_j, μ'_j, \dots) be the multiplicity sequence of $q_j \in \bar{E}$, $j \in \{1, \dots, c\}$. Assume that for some j

$$(3.2) \quad \psi \text{ contracts } T_j \text{ and } T_j \neq \Delta_{T_j} \neq 0.$$

Then we can renumber the cusps of \bar{E} so that the following hold:

- (a) $j = 1$ and the proper transform $A \subseteq X_0$ of some A_i meets $\text{tip}^+(T_1)$ and $\text{tip}^+(T_2)$.
- (b) $t_2 = 0$ and $\text{tip}^+(T_2) \subseteq \text{Exc } \psi_A$.
- (c) $\text{Exc } \psi_A = T_1 + A + T_2 \wedge (D_0 - \tilde{C}_2)$.
- (d) $\pi_0(A)$ is a line meeting \bar{E} only at q_1 and q_2 with multiplicities μ_1, μ_2 , respectively.
- (e) $\deg \bar{E} = \mu_1 + \mu_2$.
- (f) The cusps $q_1, q_2 \in \bar{E}$ are not semi-ordinary.
- (g) Let $A' \subseteq X_0$ be the proper transform of $A_{i'}$ for some $i' \neq i$. Then A' meets Q_2 . If $A' \cdot Q_1 = 0$ then $A' \cdot E_0 = A' \cdot \text{tip}^+(T_2') = 1$ and $\deg \bar{E} = \mu_2 + \mu'_2 + 1$. If additionally $s_1 = s_2 = 1$ then $\{\tau_1, \tau_2\} = \{2, 3\}$.
- (h) ψ does not touch $Q_3 + \dots + Q_c$.

Moreover, denoting by ε the number of cusps for which (3.2) holds, we have

$$(3.3) \quad b_0(\Delta_n^-) \leq \varepsilon \leq 1.$$

Proof. Without loss of generality we may assume $j = 1$.

(a) Because $T_1 \subseteq \text{Exc } \psi$, by Lemma 2.17(d) T_1 is a twig of D_0 and the proper transform of some A_i , say A , meets $\text{tip}^+(T_1)$. Then $T_1 \subseteq \text{Exc } \psi_A$ by Lemma 2.20(c). By assumption, T_1 contains a twig of D_0 of type $[(2)_{t_1}, a]$ for some $t_1 \geq 1$, $a \geq 3$, so A meets a tip $W \not\subseteq T_1$ of D_0 contracted by ψ_A . Hence, $W^2 = -(t_1 + 2) \leq -3$. We may assume that $W \subseteq Q_k$ for some $k \in \{1, 2\}$. Contract C_k and subsequent (-1) -curves in the images of Q_k as long as W is not touched and denote this morphism by σ , see Figure 10. Because Q_k contracts to a smooth point, the divisor $\sigma_* Q_k$ has a twig $T_W = [t_1 + 2, 1, (2)_{t_1}]$ such that $\sigma(W) = \text{tip}^+(T_W)$. Clearly, $W \neq \text{tip}^+(T_1)$.

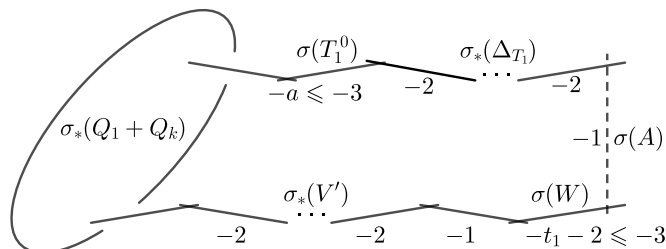

FIGURE 10. The divisor $\sigma_*(Q_k + Q_1)$ from the proof of Lemma 3.5(a).

Suppose that $W \neq \text{tip}^+(T_2)$. Then T_W is a proper subdivisor of σ_*Q_k . It follows that the proper transform $V' \subseteq X_0$ of the subchain $[(2)_{t_1}]$ of T_W is disjoint from Δ_0 and contains no branching component of Q_k .

We claim that V' has a component V disjoint from E_0 . Suppose otherwise. Then $V' = \tilde{C}_k$ and W meets C_k , so $\sigma = \text{id}$ and $t_1 = 1$. We have now $\text{Exc } \psi_A = W + A + T_1 = [3, 1, 2, 3, (2)_b]$ for some $b \geq 0$, hence ψ_A touches C_k exactly $b + 2$ times. Let $\eta: X_0 \dashrightarrow X'$ be a composition of ψ_A and $b + 1$ blowups on the proper transforms of C_k , of which the first $\min\{\tau_k, b + 1\}$ ones are centered on the proper transforms of E_0 , too. Let D' be the reduced total transform of D_0 . Then $|\eta_*C_k|$ induces a \mathbb{P}^1 -fibration of X' and, since $X' \setminus D'$ is isomorphic to an open subset of $X_0 \setminus D_0$, (2.9) implies that

$$4 \leq \eta_*C_k \cdot D' = 2 + \eta_*E_0 \cdot \eta_*C_k = 2 + \max\{\tau_k - b - 1, 0\}.$$

Hence, $\tau_k \geq 3 + b$. The divisor $\psi_*Q_k - (\Delta_n + \Upsilon_n^0) \wedge \psi_*Q_k$ contains the images of C_k and \tilde{C}_k , so $\lambda_k \geq \tau_k + 2 \geq 5 + b$. By (2.11), $\lambda_1 \geq 2$, so (2.12) implies that $k = 1$. The divisor Q_1 contains a branching component B_1 , because otherwise Q_1 is a chain and $W = \text{tip}^+(T'_1)$, contrary to Lemma 3.3. Moreover, $B_1 \neq \tilde{C}_1$ because \tilde{C}_1 is contained in the twig T_W of Q_1 . Hence, $\psi_*Q_1 - (\Delta_n + \Upsilon_n^0) \wedge \psi_*Q_1$ contains the images of C_1 , \tilde{C}_1 and B_1 , so $\lambda_1 \geq 3 + \tau_1 \geq 6 + b$. Now by (2.12) $c = 1$, $b = 0$, $\tau_1 = 3$ and

$$\psi_*Q_1 - (\Delta_n + \Upsilon_n^0) \wedge \psi_*Q_1 = \psi(C_1) + \psi(\tilde{C}_1) + \psi(B_1) = R_n - E_n.$$

The latter implies that B_1 is the only branching component of Q_1 and meets $\tilde{C}_1 \subseteq T_W$, so $Q_1 = B_1 + T_1 + T'_1 + T_W$ with $T_W = [3, 1, 2]$ and $T_1 = [2, 3]$. Then $T'_1 = [2]$ and $B_1^2 = -3$, since Q_1 contracts to a smooth point. It follows that $q_1 \in \bar{E}$ has multiplicity sequence $(22, 22, 11, 11, 7, 4, 3)$, hence $I(q_1) - M(q_1) = 1287 - 83 = 1204$. This is in contradiction with Lemma 2.10(c).

Thus V' has a component V disjoint from E_0 . Since V' is disjoint from Δ_0 , Lemma 3.2(f) gives $V \not\subseteq \psi_*^{-1}R_n$, so $V \subseteq \text{Exc } \psi$ or $\psi(V) \subseteq \Upsilon_n^0$. In the second case, $\beta_{D_n}(\psi(V)) \leq 2$ and $\psi(V)$ contains a center of ψ , so its proper transform meets a connected component of $\text{Exc } \psi$. In any case, Lemma 2.17(d) implies that V is contained in a twig of D_0 whose first tip meets a proper transform A' of some almost log exceptional curve $A_{i'}$, $i' \neq i$. It follows that $\sigma(W)$ and $\sigma_*(Q_k - W) \supseteq \sigma(V)$ are twigs of σ_*Q_k , so σ_*Q_k is a chain. We have $W \neq \text{tip}^+(T_k)$ by assumption, so $W = \text{tip}^+(T'_k)$, hence $V \subseteq T_k$ and so $\text{tip}^+(T_k)$ meets A' . Lemma 3.3 applied to A implies that $k \neq 1$, so $k = 2$. Then $\pi_0(A)$ is smooth and $\pi_0(A)^2 = A^2 + 1 + (t_2 + 2) > 1$, so $\pi_0(A)$ is a conic. We have $\pi_0(A) \cap \pi_0(A') \subseteq \{q_1, q_2\}$. Since A' meets the first exceptional curve over q_2 , we have $(\pi_0(A') \cdot \pi_0(A))_{q_2} = 1$. Similarly, since A meets the first exceptional curve over q_1 , we have $(\pi_0(A') \cdot \pi_0(A))_{q_1} = \mu$, where $\mu \geq 0$ is the multiplicity of $\pi_0(A')$ at q_1 . Therefore, $2 \deg \pi_0(A') = \pi_0(A) \cdot \pi_0(A') = \mu + 1$, hence $\mu \geq 1$, that is, $q_1 \in \pi_0(A')$. Since $T_1 \cdot A' = 0$, we have $\pi_0(A')^2 > A^2 + t_1 + 2 \geq 1$, so $\pi_0(A')$ is not a line. Denoting by ℓ_1 the line tangent to $\pi_0(A')$ at q_1 , we obtain $\deg \pi_0(A') \geq (\pi_0(A') \cdot \ell_1)_{q_1} \geq \mu + 1 = 2 \deg \pi_0(A')$; a contradiction.

(b) We have $t_2 = 0$ by (a), because $A \cdot \Delta_0 = 1$ by Lemma 2.20(a). Moreover, since $T_1 \neq \Delta_{T_1}$, we have $A + T_1 \subsetneq \text{Exc } \psi_A$, so ψ_A contracts $\text{tip}^+(T_2)$.

(c) We have $\text{tip}^+(T_2) \subseteq \text{Exc } \psi_A$ by (b), and since by definition T_2 does not contain C_2 , the maximal twig of D_0 containing $\text{tip}^+(T_2)$ equals $T_2 \wedge (D_0 - \tilde{C}_2)$. Thus $\text{Exc } \psi_A \subseteq T_1 + A + T_2 \wedge (D_0 - \tilde{C}_2)$, and by (3.2) for the opposite inclusion it suffices to show that $T_2 \wedge (D_0 - \tilde{C}_2) \subseteq \text{Exc } \psi$. Suppose that a component V of $T_2 \wedge (D_0 - \tilde{C}_2)$ is not contracted by ψ . Since V is disjoint from $\Delta_0 + E_0$, by Lemmas 2.17(g) and 3.2(f) $\psi(V) \subseteq \Upsilon_n^0$. But since $A \cdot Q_1 = A \cdot Q_2 = 1$, the component $\psi(V)$ meets two different components of $D_n - \psi(V)$; a contradiction.

(d), (e) Since A meets D_0 only at $\text{tip}^+(T_j)$ for $j \in \{1, 2\}$, we have $(\pi_0(A) \cdot \bar{E})_{q_j} = \mu_j$ and $\pi_0(A)^2 = A^2 + 2 = 1$, so $\mu_1 + \mu_2 = \pi_0(A) \cdot \bar{E} = \deg \bar{E}$.

(f) holds because by Remark 2.16(b) ψ does not touch the exceptional divisors over semi-ordinary cusps.

(g) Assume $A' \cdot Q_j = 0$ for some $j \in \{1, 2\}$. Since $\pi_0(A)$ is a line, we have $\deg \pi_0(A') = \pi_0(A) \cdot \pi_0(A') = \mu$, where μ is the multiplicity of $\pi_0(A')$ at q_{3-j} . In particular, $q_{3-j} \in \pi_0(A')$, so A' meets Q_{3-j} . Furthermore, $\pi_0(A')$ is a line, because otherwise the line tangent to some branch of $\pi_0(A')$ at $q_{3-j} \in \pi_0(A')$ meets $\pi_0(A')$ with multiplicity bigger than μ , which is impossible, because $\deg \pi_0(A') = \mu$. Thus $\pi_0(A')^2 - (A')^2 = 2$, so π_0 touches A' twice. We have $A' \cdot \text{Exc } \psi_A = 0$ by Lemma 2.20(b), so by (b) $A' \cdot (T_1 + \text{tip}^+(T_2)) = 0$. Hence, A' meets $D_0 - E_0$ only in the second component of Q_{3-j} , say V , and $A' \cdot V = 1$. By Lemma 2.20(a) A' is almost log exceptional on $(X_0, \frac{1}{2}D_0)$, so $1 = A' \cdot (D_0 - V) = A' \cdot E_0$ and $A' \cdot \Delta_0 = 1$, so $V \subseteq \Delta_0$. Because T_2 is disjoint from Δ_0 by (b), we have $V \not\subseteq T_1 + T_2$. Hence, $V = \text{tip}^+(T'_{3-j})$ and $t_{3-j} = 0$, so $j = 1$ by assumption (3.2). It follows that $\pi_0(A')$ is a line meeting \bar{E} transversally in the image of $A' \cap E_0$ and with multiplicity $\mu_2 + \mu'_2$ at q_2 . The Bezout theorem gives $\deg \bar{E} = \pi_0(A') \cdot \bar{E} = \mu_2 + \mu'_2 + 1$.

Part (e) implies now that $\mu_1 = \mu'_2 + 1$, so μ'_2 and μ_1 are coprime. Note that the inequality $\#Q_j \geq 2$ implies that $\mu_j, \mu'_j > 1$ for $j \in \{1, 2\}$. Assume $s_1 = s_2 = 1$. Then $Q_j \cdot E_0 = C_j \cdot E_0 = \tau_j$, for $j \in \{1, 2\}$. It follows that all terms in the multiplicity sequence of $q_j \in \bar{E}$, except the 1's at the end, are divisible by τ_j . Thus τ_1 and τ_2 are coprime. By (2.11) and (2.12) $\tau_1 + \tau_2 \leq \lambda_1 + \lambda_2 \leq 6$, so $\{\tau_1, \tau_2\} = \{2, 3\}$.

(h) Part (g) implies that for every $i \in \{1, \dots, n\}$, the almost log exceptional curve A_i meets the image of $Q_1 + Q_2 + E_0$ twice, so it does not meet the image of $Q_3 + \dots + Q_c$, hence by Lemma 2.17(d) the latter is not touched by ψ_i .

For the proof of (3.3), note first that $\varepsilon \leq 1$. Indeed, if $\varepsilon \neq 0$ then, numbering the cusps as above, we have $T_j \not\subseteq \text{Exc } \psi$ for $j \geq 3$ by (h) and $\Delta_{T_2} = 0$ by (b), so (3.2) holds at most for $j = 1$. Let $\hat{\Upsilon}$ be the sum of those components of $D_0 - \Delta_0 - \Upsilon_0^0$ whose image lies in Υ_n .

Claim 1. $\psi_* \hat{\Upsilon} \subseteq \Upsilon_n - \Upsilon_n^0$.

Proof. Suppose that U is a component of $\hat{\Upsilon}$ such that $\psi(U) \subseteq \Upsilon_n^0$. Then there is a unique component V of D_0 such that $\psi(U)$ meets $\psi(V)$ and by Lemma 3.2(a) one of the points of $\psi(U) \cap \psi(V)$ is a center of ψ , and the other is not. By Lemma 2.17(d) the preimage of the former is a chain $T_U^t + A + T_V$, where A_U is an almost log exceptional curve and T_U, T_V are zero or twigs of D_0 meeting U and V , respectively. In particular, $T_U + U$ is a twig of D_0 . We have $T_V \neq 0$, for otherwise $T_U \subseteq \Delta_0$ and ψ touches U once, so $U^2 = \psi(U)^2 - 1 = -2$, that is, $U \subseteq \Delta_0$, contrary to the definition of $\hat{\Upsilon}$. By Lemma 2.7(b), $V = B_j$ and $\{U + T_U, T_V\} = \{T_j, T'_j\}$ for some $j \in \{1, \dots, c\}$. This is a contradiction with Lemma 3.3. \square

Claim 2. $b_0(\Delta_0) - b_0(\Delta_n^-) = n + \#\hat{\Upsilon}$.

Proof. By definition, ψ touches exactly n connected components of Δ_0 . Let W be a connected component of Δ_0 not touched by ψ and such that $\psi_* W$ is not a connected component of Δ_n^- . Then $\psi_* W$ is a connected component of Δ_n^+ , so W meets a unique component U of $D_0 - \Delta_0 - \Upsilon_0^0$ such that $\psi(U) \subseteq \Upsilon_n$, that is, $U \subseteq \hat{\Upsilon}$. Conversely, if $U \subseteq \hat{\Upsilon}$ then by Claim 1, $\psi(U) \subseteq \Upsilon_n - \Upsilon_n^0$, so by Lemma 2.17(g), U meets a connected component W of Δ_0 such that $\psi_* W$ is a connected component of Δ_n^+ and, because $U \cdot \Delta_0 \leq 1$, such W is unique. Hence the number of connected components W as above equals $\#\hat{\Upsilon}$. \square

Let P be the sum of components of D_0 contained in Δ_0 or contracted by ψ . Then

$$D_0 - P = \psi_*^{-1} D_n \wedge (D_0 - \Delta_0) = \psi_*^{-1} (R_n + \Upsilon_n + \Delta_n) \wedge (D_0 - \Delta_0).$$

The divisor $\hat{R} = \psi_*^{-1} R_n$ is contained in R_0 by Lemma 3.2(b), so it has no common component with Δ_0 . On the other hand, by Lemma 2.17(g), $\psi_*^{-1} \Delta_n \subseteq \Delta_0$. We get

$$D_0 - P = \hat{R} + \psi_*^{-1} (\Upsilon_n) \wedge (D_0 - \Delta_0) = \hat{R} + \hat{\Upsilon} + \Upsilon_0^0.$$

By Lemma 2.17(d), P is a sum of some twigs of D_0 . In particular, it is disjoint from $E_0 + \Upsilon_0^0$ (see Remark 2.16(b)), hence every connected component of P meets $\hat{R} - E_0 + \hat{\Upsilon}$.

Claim 3. $b_0(\Delta_0) \leq \#(\hat{R} - E_0 + \hat{\Upsilon}) + \varepsilon$.

Proof. Let W be a connected component of Δ_0 . It is contained in a unique connected component P_W of P (which is a twig of D_0), and the latter meets a unique component V_W of $\hat{R} - E_0 + \hat{\Upsilon}$. Assume $V_W = V_{W'}$ for some $W \neq W'$. Then by Lemma 2.7(b), $V_W = B_j$ and $\{P_W, P_{W'}\} = \{T_j, T'_j\}$ for some $j \in \{1, \dots, c\}$. It follows that $\text{tip}^-(T_j) \subseteq P - \Delta_0 \subseteq \text{Exc } \psi$, hence by Lemma 2.17(d) ψ contracts T_j and so (3.2) holds for j . \square

We have $\#(\hat{R} - E_0) = n$ by Lemma 3.2(c), so Claims 2 and 3 give

$$b_0(\Delta_0) - \varepsilon \leq \#(\hat{R} - E_0 + \hat{\Upsilon}) = n + \#\hat{\Upsilon} = b_0(\Delta_0) - b_0(\Delta_n^-),$$

which proves $b_0(\Delta_n^-) \leq \varepsilon$ and ends the proof of (3.3). \square

Remark 3.6 (Relations with proper \mathbb{C}^* -embeddings into \mathbb{C}^2 , cf. Theorem 1.4).

- If A is as in Lemma 3.5(d) then $\bar{E} \setminus \pi_0(A) \subseteq \mathbb{P}^2 \setminus \pi_0(A)$ is the image of a proper injective morphism $\mathbb{C}^* \rightarrow \mathbb{C}^2$. Such images are classified in [CNKR09, KPR16] in case when they are smooth and in [BZ10] under some regularity conditions.
- If A' is as in Lemma 3.5(g) then $\pi_0(A')$ is a line which is a good asymptote in the sense of [CNKR09] for the above \mathbb{C}^* -embedding.

3B. Types with a singular minimal model.

In this section, we prove the following result on types with a singular minimal model.

Proposition 3.7. If X_{\min} is singular then \bar{E} is of type \mathcal{FE} or \mathcal{I} .

Throughout this section, we assume that X_{\min} is singular. Recall from (2.8) that each singular point of X_{\min} is the image of a connected component of Δ_n^- , which is a maximal (-2) -twig of D_n . By (3.3) Δ_n^- is connected, so X_{\min} has only one singular point. We denote its preimage on X_0 by

$$\widehat{\Delta}^- := \psi_*^{-1} \Delta_n^-.$$

Moreover, (3.3) implies that the condition (3.2) of Lemma 3.5 is satisfied, so we can, and will, number the cusps of \bar{E} so that Lemma 3.5(a)–(h) holds. In particular, we have an almost log exceptional curve A on $(X_0, \frac{1}{2}D_0)$ meeting $\text{tip}^+(T_1)$ and $\text{tip}^+(T_2)$. If $n > 1$ then there exists an almost log exceptional curve contracted by ψ other than A . In this case we pick one and we denote its proper transform on X_0 by A' . Such A' is almost log exceptional on $(X_0, \frac{1}{2}D_0)$ by Lemma 2.20(a). We denote by W the unique maximal (-2) -twig of D_0 meeting A' .

Recall (see (3.1)) that $(Z, \frac{1}{2}D_Z)$ denotes the image of $(X_n, \frac{1}{2}D_n)$ after the contraction of $\Upsilon_n + \Delta_n^+$. In particular, Z is smooth. For $m \geq 0$ we denote by \mathbb{F}_m the Hirzebruch surface $\mathbb{P}(\mathcal{O}_{\mathbb{P}^1} \oplus \mathcal{O}_{\mathbb{P}^1}(m))$ and by F a general fiber of the unique \mathbb{P}^1 -fibration $p_{\mathbb{F}_m} : \mathbb{F}_m \rightarrow \mathbb{P}^1$.

Lemma 3.8 (The geometry of $D_0 + A + A'$ in case of a singular minimal model). Let $A, \widehat{\Delta}^-$ and (Z, D_Z) be as above. Then:

- (a) The cusps $q_j \in \bar{E}$ for $j \geq 3$ are semi-ordinary and $q_1, q_2 \in \bar{E}$ are not.
- (b) $R_n = E_n + \psi(C_1) + \psi(C_2)$.
- (c) $s_j = 1$ for $j \in \{1, \dots, c\}$ (see Notation 2.6(d)).
- (d) $\text{Exc } \psi_A = T_1^t + A + T_2$.
- (e) $n = 2$.
- (f) $A' + W$ is disjoint from $T_1 + A + T_2$.
- (g) $Q_1 = T_1 + C_1 + \widehat{\Delta}^- = [(2)_{t_1}, 3, 1, 2]$.
- (h) Either $Q_2 = T_2 + C_2 + W = [t_1 + 2, 1, (2)_{t_1}]$ or Q_2 is a fork with maximal twigs $T_2 = [t_1 + 2]$, $W + C_2$ and $\widehat{\Delta}^+ = [(2)_{t_1}]$, where $\psi_* \widehat{\Delta}^+ \subseteq \Delta_n^+$.
- (i) $Z \cong \mathbb{F}_2$, $\psi^+(\widehat{\Delta}^-)$ is the negative section and $D_Z \cdot F = 4$.
- (j) $D_Z = \psi^+(E_0) + \psi^+(C_1) + \psi^+(C_2) + \psi^+(\widehat{\Delta}^-)$ and $D_Z - \psi^+(C_1)$ is horizontal.

Proof. (a) The cusps q_1, q_2 are not semi-ordinary by Lemma 3.5(f). Suppose that $c \geq 3$ and $q_3 \in \bar{E}$ is not ordinary. By Remark 2.18 $\sum_{j=1}^3 \lambda_j \geq \sum_{j=1}^3 \tau_j \geq 6$, so by (2.12) the equalities hold. Therefore, $\lambda_3 = 2$, hence $\tau_3 = 2$ and $\psi_* Q_3 \subseteq \psi(C_3) + \Upsilon_n + \Delta_n$. Lemma 3.5(g) implies that ψ does not touch Q_3 , so by Lemma 3.2(a) $\psi_* Q_3 \subseteq \psi(C_3) + \Delta_n$, and thus $Q_3 \subseteq C_1 + \Delta_0$ by Lemma 2.17(g). Lemma 2.7(c) shows that q_3 is semi-ordinary.

Before we prove the remaining parts of Lemma 3.8, we make the following observation.

Claim 1. If $\widehat{\Delta}$ is irreducible then (i) holds and D_Z contains at most one fiber of $p_{\mathbb{F}_2}$.

Proof. The surface Z is smooth, rational and $\rho(Z) = \rho(X_{\min}) + \#\widehat{\Delta}^- = 2$, so Z is a Hirzebruch surface. It is \mathbb{F}_2 , because it contains the (-2) -curve $\psi^+(\widehat{\Delta}^-) = \alpha_n^+(\Delta_n^-)$. If $D_Z \cdot F \leq 3$ then $Z \setminus D_Z$, which is an open subset of $\mathbb{P}^2 \setminus \bar{E}$, admits a \mathbb{C}^1 -, \mathbb{C}^* - or a \mathbb{C}^{**} -fibration. Thus by (2.9) $D_Z \cdot F \geq 4$. Since $-(2K_{X_{\min}} + D_{\min})$ is ample, we have

$$0 > \alpha_n^-(F) \cdot (2K_{X_{\min}} + D_{\min}) = F \cdot (2K_Z + D_Z - \frac{1}{2}\alpha_n^+(\Delta_n^-)) = -4 + F \cdot D_Z - \frac{1}{2},$$

so $F \cdot D_Z \leq 4$ and (i) follows. Since Δ_n^- is a twig of D_n , it meets a unique component of $D_n - \Delta_n^-$, so $\alpha_n^+(\Delta_n^-)$ meets a unique component of $D_Z - \alpha_n^+(\Delta_n^-)$. Because $\alpha_n^+(\Delta_n^-)$ is a section, D_Z contains at most one fiber of $p_{\mathbb{F}_2}$. \square

(b) By (a), $q_1, q_2 \in \bar{E}$ are not semi-ordinary, so

$$E_n + \psi(C_1) + \psi(C_2) \subseteq R_n \subseteq \psi_*(Q_1 + Q_2).$$

Suppose that the first inclusion is strict. Let G be a component of $\psi_*^{-1}R_n - C_1 - C_2$. Then by (a), $G \subseteq Q_1 + Q_2$. We claim that $\tau_1 - s_1 + \tau_2 - s_2 \geq 3$. Indeed, if $s_j = 0$ for some $j \in \{1, 2\}$ then this follows from the inequalities $\tau_1, \tau_2 \geq 2$. Assume $s_1 = s_2 = 1$. Then $G \cdot E_0 = 0$, so Lemma 3.2(d),(e) implies that the proper transform on X_0 of some A_i meets E_0 , and thus $\tau_1 + \tau_2 = 5$ by Lemma 3.5(g).

The divisor $\psi_*(Q_1 + Q_2) \wedge R_n$ contains images of C_1 , C_2 and G , so

$$\sum_{j=1}^c \lambda_j \geq 3 + \tau_1 - s_1 + \tau_2 - s_2 + \#\Delta_n - b_0(\Delta_n) \geq 6.$$

Hence (2.12) implies that the equalities hold. In particular, $c = 2$, $\#\Delta_n = b_0(\Delta_n)$ and if $s_j = 0$ for some $j \in \{1, 2\}$ then $s_{3-j} = 1$ and $\tau_1 = \tau_2 = 2$.

From the equality $\#\Delta_n = b_0(\Delta_n)$ we get $\widehat{\Delta}^- = [2]$, so by Claim 1, $Z \cong \mathbb{F}_2$ with negative section $\psi^+(\widehat{\Delta}^-)$. The divisor D_Z contains images of E_0 , C_1 , C_2 , G and $\widehat{\Delta}^-$. Again from Claim 1 we infer that $\#D_Z = 5$ and D_Z consists of a fiber and four 1-sections. We have $\psi^+(C_j) \cdot \psi^+(E_0) \geq C_j \cdot E_0 \geq 2$ for $j \in \{1, 2\}$, which implies that $\psi^+(C_j)$ and $\psi^+(E_0)$ are horizontal. Thus $\psi^+(G)$ is a fiber, so it meets $\psi^+(\widehat{\Delta}^-)$. Because ψ^+ does not touch $\widehat{\Delta}^-$, the latter is a unique (-2) -twig of D_0 meeting G (see Lemma 2.7(b)). It follows from Lemma 3.2(f) that $G \cdot E_0 > 0$, so $G = \widetilde{C}_j$ for some $j \leq 2$. The components of $D_Z - \psi^+(\widehat{\Delta}^-) - \psi^+(G)$ are 1-sections disjoint from the negative section $\psi^+(\widehat{\Delta}^-)$, so they are linearly equivalent to $2\psi^+(G) + \psi^+(\widehat{\Delta}^-)$. We obtain that $\psi^+(E_0)^2 = 2$ and $\psi^+(E_0) \cdot \psi^+(C_k) = 2$ for $k \in \{1, 2\}$. The latter implies that $\psi^+(E_0) \cdot \psi^+(V) = E_0 \cdot V$ for every component V of $D_0 - E_0$ not contracted by ψ^+ . Hence by Lemma 2.17(e) ψ^+ does not touch E_0 . Therefore, $E^2 = \psi^+(E_0)^2 - (\tau_1 + \tau_2) = -2$. Because $s_{3-j} = 1$ and $\tau_1 = \tau_2 = 2$, this is a contradiction with Lemma 2.11(c).

(c) This follows from (b), because R_n does not contain $\psi(\widetilde{C}_j)$ for $j \in \{1, \dots, c\}$.

(d) This follows from (c) and Lemma 3.5(c).

(e) This follows from (b) and Lemma 3.2(c).

(f) We have $W + A' \subseteq \text{Exc } \psi_{A'}$ and, by (d), $T_1 + A + T_2 = \text{Exc } \psi_A$. These divisors are disjoint by Lemma 2.20(b).

Before we prove (g), we need some preparation. If C_j is not a tip of Q_j for some $j \in \{1, 2\}$ then, because Q_j contracts to a smooth point, (c) implies that C_j meets a twig of D_0 other than T_j . Denote this twig by V_j and put $V_j = 0$ if C_j is a tip of Q_j . Fix $j \in \{1, 2\}$. We need the following claims.

Claim 2. If Q_j is not a chain then Q_{3-j} is a chain, $\psi(B_j) \subseteq \Upsilon_2$ and Q_j is a fork with maximal twigs T_j , $V_j + C_j$ and some $\widehat{\Delta}^+$ for which $\psi_*\widehat{\Delta}^+ \subseteq \Delta_2^+$ (see Figure 11).

Proof. Lemma 2.7(b) gives $B_j \neq C_j$, hence $\psi(B_j) \not\subseteq R_2$ by (b). We have $\psi(B_j) \not\subseteq \Delta_2$ by Lemma 2.17(g), so $\psi(B_j) \subseteq \Upsilon_2$. Since B_1, B_2 meet T_1, T_2 , respectively, from Lemma 3.5(c) we infer that $\psi(B_1)$ meets $\psi(B_2)$. Then by Lemma 2.17(b), $\psi(B_{3-j}) \not\subseteq \Upsilon_2$, so by (b), $B_{3-j} = C_{3-j}$, that is, Q_{3-j} is a chain. Moreover, $\psi(B_j) \not\subseteq \Upsilon_2^0$, because $\psi(B_j)$ meets $\psi(B_{3-j}) \subseteq \psi_*Q_{3-j}$ and $\psi_*(Q_j - B_j)$. Thus B_j meets $\psi_*^{-1}\Delta_2^+$, which proves the claim. \square

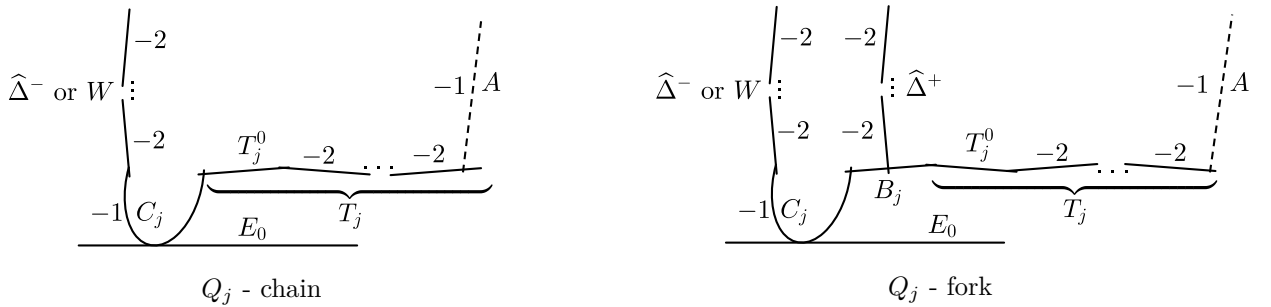

FIGURE 11. Two possible shapes of Q_j according to Claims 2 and 3 in the proof of Lemma 3.8.

Claim 3. The divisor $Q_1 + Q_2$ contains four or five maximal twigs of D_0 , namely T_1 , T_2 , $\widehat{\Delta}^-$, W and (possibly) $\widehat{\Delta}^+$.

Proof. By Claim 2, $Q_1 + Q_2$ contains at most five maximal twigs of D_0 . Among them there are T_1, T_2 , which are not (-2) -twigs by Lemma 3.5(b), and (-2) -twigs: $\widehat{\Delta}^-$, the (-2) -twig $W \neq \widehat{\Delta}^-$ meeting A' and, in case there are exactly five twigs, also $\widehat{\Delta}^+ \neq W, \widehat{\Delta}^-$. \square

Claim 4. $T_1 = [(2)_{t_1}, 3]$ and $T_2 = [t_1 + 2]$.

Proof. By Claim 3, $T'_j \subseteq \Delta_0$ for $j \in \{1, 2\}$ (see Notation 2.6(i)), so because $T_j + [1] + T'_j$ contracts to a smooth point, we get $T_j = [(2)_{t_j}, \#T'_j + 2]$. We have $t_1 > 0$ and $t_2 = 0$ by Lemma 3.5(b), so (d) gives $\text{Exc } \psi_A = [\#T'_1 + 2, (2)_{t_1}, 1, \#T'_2 + 2]$. Because $\text{Exc } \psi_A$ contracts to a smooth point, we get $\#T'_1 = 1$ and $\#T'_2 = t_1$. \square

We return to the proof of Lemma 3.8.

(g) Suppose that Q_1 is not a chain. By Claim 2, Q_1 is a fork and $\psi(B_1) \subseteq \Upsilon_2$. Part (d) and Claim 4 imply that ψ_A touches B_1 once. By Lemma 3.2(a) the point $\psi(A)$ is the unique center of ψ on $\psi(B_1)$, so $B_1^2 = \psi(B_1)^2 - 1 = -2$. Since by Claim 2, C_1 meets B_1 , the contractibility of Q_1 to a smooth point implies that C_1 is a tip of Q_1 , contrary to Claim 3.

Thus Q_1 is a chain. Because $\text{tip}^+(T_1)$ contracts last among the components of Q_1 , Claim 4 shows that $Q_1 = [(2)_{t_1}, 3, 1, 2]$. It remains to prove that $V_1 = \widehat{\Delta}^-$. Suppose the contrary. Then by Claim 3, $V_1 = W$, so Q_1 meets A' . By Lemma 3.5(g), A' meets Q_2 . We have $A' \cdot T_2 = 0$ by (f) and $A' \cdot V_2 = 0$, because $V_2 = \widehat{\Delta}^-$ by Claim 3. Claim 2 implies that $Q_2 - C_2 - T_2 - V_2$ is either zero or equal to $B_2 + \widehat{\Delta}^+$, which is a proper transform of a connected component of $\Upsilon_2 + \Delta_2^+$ containing the point $\psi(A)$. We infer from Lemma 3.2(a) that $A' \cdot (Q_2 - C_2 - T_2 - V_2) = 0$, so A' meets C_2 . By (d) and (f) the curve A meets $D_0 + A'$ only in the components of Q_1 and Q_2 which are contracted last by π_0 . Hence, $\pi_0(A)$ is a line meeting $\pi_0(A')$ only at q_1, q_2 with the least possible multiplicity, which equals respectively 1 and, say, μ for some $\mu \geq 2$. Thus $\deg \pi_0(A') = \pi_0(A) \cdot \pi_0(A') = \mu + 1$, so the intersection number at q_2 of $\pi_0(A')$ and its tangent line equals at most $\mu + 1$. But this number is the sum of at least two initial terms of the multiplicity sequence of $q_2 \in \pi_0(A')$, so this sequence equals $(\mu, 1, \dots)$. It follows that $Q_2 = [\mu + 1, 1, (2)_{\mu-1}]$. Claim 4 implies that $t_1 = \mu - 1$, so the contraction of Q_1 touches A' exactly $\mu + 1$ times. Therefore,

$$(\mu + 1)^2 = \pi_0(A')^2 = (A')^2 + (\mu + 1) + (\mu + \mu^2) = (\mu + 1)^2 - 1;$$

a contradiction.

(h) Part (g) implies that $\widehat{\Delta}^- \not\subseteq Q_2$, so by Claim 3, $V_2 = W$. Claim 4 gives $T_2 = [t_1 + 2]$, so $T'_2 = [(2)_{t_1}]$ by the contractibility of Q_2 to a smooth point. This proves (h) if Q_2 is a chain. If Q_2 is a fork then (h) follows from Claim 2.

(i) This follows from Claim 1, because by (g), $\widehat{\Delta}^- = [2]$.

(j) The first statement follows from (b). To prove the second one, recall that ψ^+ does not touch $\widehat{\Delta}^-$, so $\psi^+(\widehat{\Delta}^-) \cdot \psi_*^+(D_0 - C_1) = \widehat{\Delta}^- \cdot (D_0 - C_1) = 0$ by (g). The curve $\psi^+(\widehat{\Delta}^-)$ is a section by Claim 1, so $\psi_*^+(D_0 - C_1)$ contains no fiber. \square

Proposition 3.9. If D_Z contains a fiber then \bar{E} is of type \mathcal{FE} (see Figure 12).

Proof. By Lemma 3.8(j) the unique fiber in D_Z equals $\psi^+(C_1)$. Because $C_1^2 = -1 = \psi^+(C_1)^2 - 1$ and ψ_A touches C_1 once, we have $A' \cdot C_1 = 0$. In fact, $A' \cdot Q_1 = 0$, because $Q_1 - C_1 = T_1 + \widehat{\Delta}^-$ by Lemma 3.8(g) and $T_1 \cdot A' = 0$ by Lemma 3.8(f). By Lemma 3.5(g) A' meets $\text{tip}^+(T'_2)$ and E_0 , so $W = T'_2$. Lemma 3.8(h) implies that $Q_2 = [t_1 + 2, 1, (2)_{t_1}]$. It follows from Lemma 3.8(b) that

$$4 = \psi^+(C_1) \cdot D_Z = \psi^+(C_1) \cdot (\psi^+(\widehat{\Delta}^-) + \psi^+(C_2) + \psi^+(E_0)) = 2 + \tau_1,$$

so $\tau_1 = 2$. Lemma 3.5(g) gives $\tau_2 = 3$. We have $\psi^+(E_0) \cdot \psi^+(C_1) = \tau_1 = 2$ and $\psi^+(E_0) \cdot \psi^+(\widehat{\Delta}^-) = 0$, which by numerical properties of \mathbb{F}_2 gives $\psi^+(E_0) \sim -K_{\mathbb{F}_2}$, hence $p_a(\psi^+(E_0)) = 1$. It follows (see the proof of Lemma 2.10) that $\text{Sing } \psi^+(E_0)$ is an ordinary cusp, thus $c = 3$ and q_3 is ordinary. Since $\tau_1 = 2$, $\tau_2 = 3$ and $s_1 = s_2 = 1$, we see that \bar{E} is of type $\mathcal{FE}(\gamma)$, where $\gamma = t_1 + 4 \geq 5$ by Lemma 3.5. We have $E^2 = -\gamma$ by Lemma 2.10, see Figure 12. Note that the order of cusps $q_1, q_2 \in \bar{E}$ in Figure 12 is different than the one in Definition 1.3. \square

Proposition 3.10. If D_Z is horizontal then \bar{E} is of type \mathcal{I} (see Figure 13).

Proof. Lemma 3.8(i),(j) shows that D_Z consists of four 1-sections. In particular, $\psi^+(E_0)$ is smooth, so $c = 2$ by Lemma 3.8(a) and Remark 2.16(b). Since ψ^+ does not touch $\widehat{\Delta}^-$, by Lemma 3.8(g) we have $\psi^+(C_1) \cdot \psi^+(\widehat{\Delta}^-) = 1$ and $\psi^+(C_2) \cdot \psi^+(\widehat{\Delta}^-) = \psi^+(E_0) \cdot \psi^+(\widehat{\Delta}^-) = 0$. Using elementary numerical properties of Hirzebruch surfaces, we compute that

$$\psi^+(C_1)^2 = 4, \quad \psi^+(C_1) \cdot \psi^+(C_2) = \psi^+(C_1) \cdot \psi^+(E_0) = 3 \quad \text{and} \quad \psi^+(C_2) \cdot \psi^+(E_0) = 2.$$

If ψ^+ touches E_0 then we infer that $\tau_1 < 3$ or $\tau_2 < 2$ and that, by Lemma 3.2(e), A' meets E_0 . This is impossible by Lemma 3.5(g). Hence, $\tau_1 = 2$, $\tau_2 = 3$ and both centers of ψ^+ are contained in $\psi^+(C_1) + \psi^+(C_2)$. We have $\psi^+(C_1) \cdot \psi^+(C_2) = 3$ and $C_1 \cdot C_2 = 0$, so from Lemma 2.17(e) we infer that $\psi^+(C_1)$ and

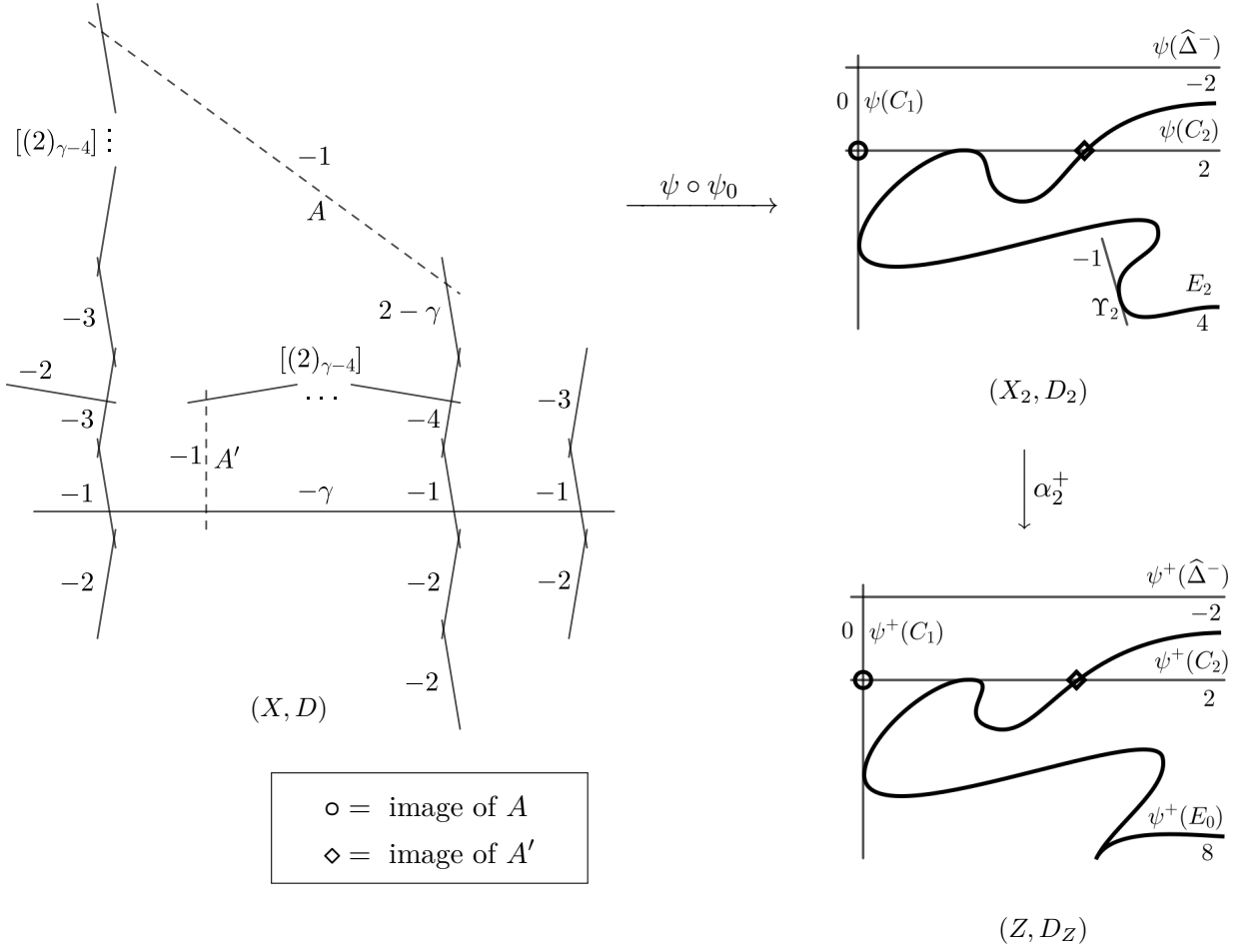

FIGURE 12. Type $\mathcal{FE}(\gamma)$, $\gamma \geq 5$ (in Def. 1.3, $q_1, q_2 \in \bar{E}$ are in the opposite order).

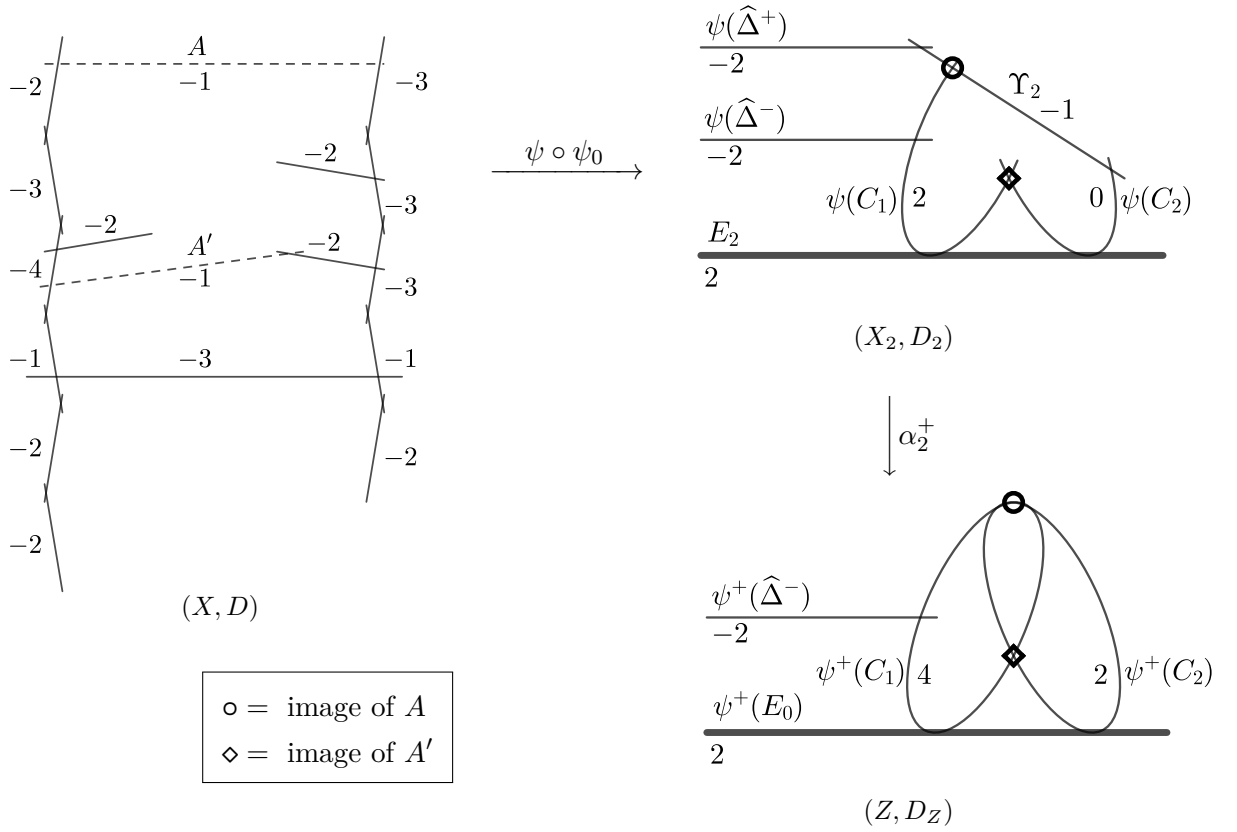

FIGURE 13. Type \mathcal{I} .

$\psi^+(C_2)$ meet in two points, with multiplicity 1 and 2. The latter point is the image of $\Upsilon_2 + \Delta_2^+ = [1, 2]$. Suppose that Q_2 is a chain. By Lemma 3.8(g),(h), $\psi_*^{-1}(\Upsilon_2 + \Delta_2^+) = W = [(2)_{t_1}]$, so $t_1 = 2$. Then $Q_1 = [2, 2, 3, 1, 2]$, $Q_2 = [4, 1, 2, 2]$ and A' meets D_0 only in C_1 and in the third component of Q_2 . We compute that $\pi_0(A')^2 = -1 + (2 + 3 \cdot 2^2) + (2 + 2^2) = 19$; a contradiction. Thus Q_2 is a fork as in Lemma 3.8(h). We have $\hat{\Delta}^+ = \psi_*^{-1}\Delta_2^+ = [2]$, so $t_1 = 1$. Now $\psi(B_2) \subseteq \Upsilon_2$ and ψ_A touches B_2 twice by Lemma 3.8(d). Since $\psi_{A'}$ does not touch B_2 by Lemma 3.2(a), $B_2^2 = \psi(B_2)^2 - 2 = -3$. Because $B_2 + C_2 + W$ contracts to a smooth point, we get $W = [2]$. This determines the weighted graph of $Q_1 + Q_2$. Since $\tau_1 = 3$, $\tau_2 = 2$ and $s_1 = s_2 = 1$, we see that \bar{E} is of type \mathcal{I} . Note that $E^2 = -3$ by Lemma 2.10, see Figure 13. \square

3C. Types with a smooth minimal model.

In this section we prove the following result on types with a smooth minimal model.

Proposition 3.11. If X_{\min} is smooth then \bar{E} is of type Q_3 , Q_4 , \mathcal{FZ}_2 , \mathcal{H} or \mathcal{J} .

Throughout this section, we assume that X_{\min} is smooth. The peeling morphism (2.8) between the almost minimal model $(X_n, \frac{1}{2}D_n)$ and the minimal model $(X_{\min}, \frac{1}{2}D_{\min})$ is now just the contraction of $\Upsilon_n + \Delta_n^+$. Equivalently, $\Delta_n^- = 0$.

We collect some properties of D_{\min} which are consequences of (2.9).

Lemma 3.12 (The geometry of D_{\min} in case of a smooth minimal model). Let ψ^+ and D_{\min} be as above (see (3.1)). Then:

- (a) $X_{\min} \cong \mathbb{P}^2$ and $\deg D_{\min} = 5$.
- (b) $s_j = 1$ for $j \in \{1, \dots, c\}$.
- (c) The only singularities of $\psi^+(E_0)$ are images of semi-ordinary cusps of \bar{E} through $\psi^+ \circ \pi_0^{-1}$, which is an isomorphism on some neighborhood of those cusps.
- (d) Components of $D_{\min} - \psi^+(E_0)$ are smooth.
- (e) Components of D_{\min} meet in $2n$ points, in each point exactly two of them.
- (f) $n = \#D_{\min} - 1 \in \{0, 2, 3\}$
- (g) If $n \neq 0$ then $\deg \psi^+(E_0) \leq 3$.
- (h) If D_{\min} contains two conics then they meet in two points, with multiplicities 3 and 1. The remaining part of D_{\min} is a line tangent to those conics off their common points.

Proof. (a),(b) Proposition 2.15(b) and (2.9) imply that $(X_{\min}, \frac{1}{2}D_{\min})$ is log del Pezzo surface of Picard rank one. Since X_{\min} is smooth, $X_{\min} \cong \mathbb{P}^2$. Since $-(2K_{X_{\min}} + D_{\min})$ is ample, $0 > \deg(2K_{X_{\min}} + D_{\min}) = -6 + \deg D_{\min}$, that is, $\deg D_{\min} \leq 5$. Suppose the inequality is strict or that $s_j = 0$ for some $j \in \{1, \dots, c\}$. Let μ_p be the multiplicity of a point $p \in D_{\min}$. If $\deg D_{\min} \in \{3, 4\}$ then, because the components of D_{\min} are rational, we can choose p with $\mu_p \geq 2$. If $s_j = 0$ then we have $\mu_p \geq 3$ for $\{p\} = \psi^+(C_j \cap E_0 \cap \tilde{C}_j)$. In any case, we have $\deg D_{\min} - \mu_p \leq 2$, so the pencil of lines through p induces a \mathbb{C}^1 -, \mathbb{C}^* - or a \mathbb{C}^{**} -fibration of $X_{\min} \setminus D_{\min}$. The latter is isomorphic to an open subset of $\mathbb{P}^2 \setminus \bar{E}$. This is a contradiction with (2.9).

(c),(d) Let G be a component of D_0 such that $\psi^+(G)$ is singular. Because $\psi(G)$ is smooth, $\text{Sing } \psi^+(G)$ consists of images of those components of Υ_n which meet R_n only in $\psi(G)$. Let U be a proper transform on X of such a component. If $U \subseteq \Upsilon_0$ then by Remark 2.16(b), $G = E_0$ and $\psi^+(U)$ is an image of a semi-ordinary cusp of \bar{E} . Assume $U \not\subseteq \Upsilon_0$. We infer from Lemma 3.2(a) that one of the points of $\psi(G) \cap \psi(U)$ is the image of the point $G \cap U$, and the other is the center of ψ contained in $\psi(U)$. By Lemma 2.17(d), the preimage of the latter point is a chain $T_U^t + A + T_G$, where A is the proper transform of some A_i and T_U, T_G are zero or twigs of D_0 meeting U and G , respectively. Since $\psi(U) \subseteq \Upsilon_n$, either $\beta_{D_0}(U) = 2$, or U meets a connected component of $\psi_*^{-1}\Delta_n^+$, say Δ_U . By Lemma 2.17(g), $\Delta_U \subseteq \Delta_0$. If $G = E_0$ then, since E_0 meets no twigs of D_0 , we have $T_{E_0} = 0$, so $0 \neq T_U \subseteq \Delta_0$, and $\beta_{D_0}(U) \geq 3$. But then U meets two (-2) -twigs of D_0 , which is impossible. Hence, $G \neq E_0$. In particular, we proved (c).

Suppose that $D_0 - E_0 - G$ contains a component V not contracted by ψ^+ . Because $\psi^+(G)$ is singular, $\deg \psi^+(G) \geq 3$. We infer from (a) that $\#D_{\min} = 3$, $\deg \psi^+(G) = 3$ and that $\psi^+(E_0)$ and $\psi^+(V)$ are lines. Hence, $V \cdot E_0 \leq \psi^+(V) \cdot \psi^+(E_0) = 1$, so $V \neq C_j$ for $j \in \{1, \dots, c\}$. Part (b) implies that $\psi^+(V) \cap \psi^+(E_0)$ is a center of ψ^+ , other than $\text{Sing } \psi^+(G)$. Moreover, since $\psi^+(V) \cdot \psi^+(G) = 3 > V \cdot G$, the set $\psi^+(V) \cap \psi^+(G)$ contains another center of ψ^+ . Hence, $n \geq 3$. But $n = \#D_{\min} - 1 = 2$ by Lemma 3.2(c); a contradiction.

Thus, $G = C_1$ and $D_{\min} = \psi^+(E_0) + \psi^+(C_1)$. Lemma 3.2(c) gives $n = 1$, hence

$$D_1 = E_1 + \psi(C_1) + \psi(U) + \psi_*\Delta_U + \psi_*(\Upsilon_0 + \Delta_0^+).$$

Put $b = \#\Delta_U$. We have $b \geq 1$, because otherwise $Q_1 = T_{C_1} + C_1 + U + T_U^t$ is a chain and A meets it in tips, contrary to Lemma 3.3. Because Q_1 contracts to a smooth point, we have $T_{C_1} = [(2)_{-U^2-2}] \subseteq \Delta_0$ and either $T_U = 0$ or $T_U = [(2)_{t_1}, b+2]$. Hence,

$$\text{Exc } \psi = T_U^t + A + T_{C_1} = [1, (2)_{-U^2-2}] \text{ or } [b+2, (2)_{t_1}, 1, (2)_{-U^2-2}].$$

In both cases, ψ touches C_1 at most twice, so $\psi(C_1)^2 \leq C_1^2 + 2 = 1$.

The contraction of each component of $\psi_*(U + \Delta_U)$ increases the arithmetic genus (respectively, the self-intersection number) of the image of $\psi(C_1)$ by 1 (respectively, by 4). Hence,

$$b+1 = p_a(\psi^+(C_1)) = \frac{1}{2} \deg(\psi^+(C_1))(\deg \psi^+(C_1) - 3) + 1 \quad \text{and} \quad 4(b+1) = (\deg \psi^+(C_1))^2 - (\psi(C_1))^2.$$

Because $b \geq 1$, the first equation gives $\deg \psi^+(C_1) \geq 4$, so by (a), $\deg \psi^+(C_1) = 4$ and $b = 2$. Now the second equation gives $(\psi(C_1))^2 = 4$; a contradiction.

(e) For a reduced effective divisor V denote by $\nu(V)$ the number of points where exactly two components of V meet. Let R be the proper transform of D_{\min} on X_0 . We have $R = \psi_*^{-1}R_n$ (see (2.8)), so by Lemma 3.2(b), R is a connected subdivisor of R_0 . Hence the graph of R has no loops, and it follows from (b) that no three components of R meet at the same point. As a consequence, $\nu(R) = \#R - 1$. From Lemma 3.2(c) we obtain $\nu(R) = n$.

Parts (c), (d) imply that the components of D_{\min} have no singularities but cusps. Hence by Lemma 3.2(g) the centers of ψ^+ are the cusps of $\psi^+(E_0)$ and some n points, at each of which exactly two components of D_{\min} meet. Therefore, $\nu(D_{\min}) = \nu(R) + n = 2n$.

(f) We have $n = \#D_{\min} - 1$ by Lemma 3.2(c). If $n \geq 4$ then by (a), $n = 4$ and D_{\min} is a union of five lines, which by (e) meet in eight points, exactly two at each point. This is impossible, hence $n \leq 3$. Suppose that $n = 1$. Then $D_{\min} = \psi^+(E_0) + \psi^+(C_1)$ and $\psi^+(C_1)$ is smooth by (d). The point $\psi^+(A_1)$ is a singular point of D_{\min} other than $\psi^+(C_1 \cap E_0)$ and the cusps of $\psi^+(E_0)$, so it is a common point of $\psi^+(C_1)$ and $\psi^+(E_0)$. Lemma 3.2(e) implies that $\text{Exc } \psi^+ = A_1 + \Delta_{A_1}$, where Δ_{A_1} is a (-2) -twig of D_0 meeting C_1 . It follows that $Q_1 = C_1 + \Delta_{A_1}$, so by Lemma 2.7(c), $\Delta_{A_1} = \Delta_{T_1} = [(2)_{t_1}]$ and $q_1 \in \bar{E}$ has multiplicity sequence $(\tau_1)_{t_1+1}$. We have $\tau_1 \geq 3$, because $q_1 \in \bar{E}$ is not semi-ordinary. Moreover, $\pi_0(A_1)^2 \geq 1$, so A_1 meets $\text{tip}^-(\Delta_{T_1})$ and $t_1 \geq 2$. We obtain $\psi^+(E_0) \cdot \psi^+(C_1) = t_1 + \tau_1 \geq 5$. But $\deg \psi^+(E_0) + \deg \psi^+(C_1) = 5$ by (a) and $\deg \psi^+(C_1) \leq 2$ by (d), so $\deg \psi^+(E_0) = 3$, $\deg \psi^+(C_1) = 2$ and hence $t_1 + \tau_1 = 6$. Now $(\deg \pi_0(A_1))^2 = A_1^2 + t_1 = t_1 - 1 \leq 2$, so $t_1 = 2$ and $\tau_1 = 4$. Thus, $q_1 \in \bar{E}$ has multiplicity sequence $(4)_3$, see Lemma 2.7(c). Because $\psi^+(E_0)$ has one ordinary cusp, $c = 2$ and $q_2 \in \bar{E}$ is ordinary. This is a contradiction with Lemma 2.10(c).

(g) Parts (a),(f) give $\deg \psi^+(E_0) \leq \deg D_{\min} - (\#D_{\min} - 1) = 5 - n \leq 3$.

(h) Let G_1, G_2 be two conics contained in D_{\min} . The pencil generated by them gives a map $g: \mathbb{P}^2 \dashrightarrow \mathbb{P}^1$. Put $\ell = D_{\min} - G_1 - G_2$. Part (a) gives $\deg \ell = 5 - 2 - 2 = 1$, so ℓ is a line. By (e), ℓ meets G_1, G_2 in different points. We have $n = 2$ by (f), so by (e), the components of D_{\min} meet in four points. Hence, $\#G_1 \cap G_2 = 4 - \#\ell \cap G_1 - \#\ell \cap G_2 \leq 2$. In fact, the equality holds, because otherwise $g|_{X_{\min} \setminus D_{\min}}$ is a \mathbb{C}^{**} -fibration, which is impossible by (2.9). Hence, $G_1 \cap G_2 = \{p_1, p_2\}$ for some $p_1 \neq p_2$ and ℓ is tangent to G_1, G_2 off p_1, p_2 . Let ℓ_{12} be the line joining p_1 with p_2 . The morphism $g|_{\ell}: \ell \rightarrow \mathbb{P}^1$ has degree 2. We have $(G_1 \cdot G_2)_{p_i} \neq 2$ for some $i \in \{1, 2\}$, for otherwise $g|_{\ell}$ is ramified at $\ell \cap G_1, \ell \cap G_2$ and $\ell \cap \ell_{12}$, contrary to the Hurwitz formula. The result follows. \square

We will now consider the cases $n = 0, 2, 3$ separately.

Proposition 3.13. If $n = 0$ then \bar{E} is of type \mathcal{Q}_3 or \mathcal{Q}_4 (see Figures 14–15).

Proof. By Lemma 3.2(h) we have $D_0 - E_0 = \Upsilon_0 + \Delta_0^+$, so $(X_{\min}, D_{\min}) = (\mathbb{P}^2, \bar{E})$. Lemma 3.12(a) implies that \bar{E} is a quintic with only semi-ordinary cusps. Thus every $q_j \in \bar{E}$, $j \in \{1, \dots, c\}$, has multiplicity sequence $(2)_{t_j+1}$ for some $t_j \geq 0$ (see Example 2.8). Lemma 2.10(c) in this case reads as

$$(3.4) \quad \sum_{j=1}^c (t_j + 1) = 6.$$

We claim that $t_j \leq 2$ for every $j \in \{1, \dots, c\}$. Suppose that $t_1 \geq 3$. Let $\ell_1 \subseteq \mathbb{P}^2$ be the line tangent to \bar{E} at $q_1 \in \bar{E}$. The number $(\ell_1 \cdot \bar{E})_{q_1}$ is the sum of at least two initial terms of the multiplicity sequence of $q_1 \in \bar{E}$, and since $(\ell \cdot \bar{E})_{q_1} \leq \deg \bar{E} = 5$, we get $(\ell_1 \cdot \bar{E})_{q_1} = 4$. The proper transform L_1 of ℓ_1 on X_0 satisfies $L_1 \cdot Q_1 = 1$, so it meets the unique component of $\pi_0^{-1}(q_1)$ of multiplicity 4, that is, the second component of Q_1 . Moreover, $L_1^2 = -1$, $L_1 \cdot D_0 = 2$ and L_1 meets D_0 in Q_1 and E_0 . The sum of L_1 and the first three exceptional curves over q_1 supports a fiber of a \mathbb{P}^1 -fibration which restricts to a \mathbb{C}^{**} -fibration of $\mathbb{P}^2 \setminus \bar{E}$; a contradiction with (2.9).

Assume that $t_j = 0$ for all $j \geq 2$. Let σ be a blowup at q_1 . Then the pencil of lines through $q_1 \in \bar{E}$ induces a morphism $\sigma_*^{-1}\bar{E} \rightarrow \mathbb{P}^1$ of degree $\deg \bar{E} - 2 = 3$, ramified at every $\sigma^{-1}(q_j)$, $j \geq 2$ and, if $t_1 > 0$, also at the point infinitely near to q_1 on $\sigma_*^{-1}\bar{E}$. Hence the Hurwitz formula implies that $c \leq 5$ and $c \leq 4$ if $t_1 > 0$. Since $t_1 \leq 2$ and $t_1 + c = 6$ by (3.4), it follows that $t_1 = 2$ and that $c = 4$, so \bar{E} is of type \mathcal{Q}_4 , see Figure 14. Note that $E^2 = -7$ by Lemma 2.10.

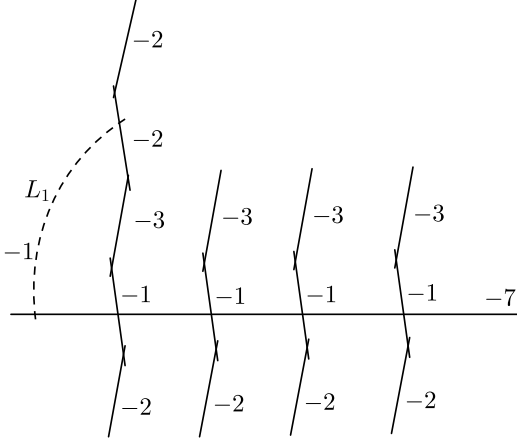
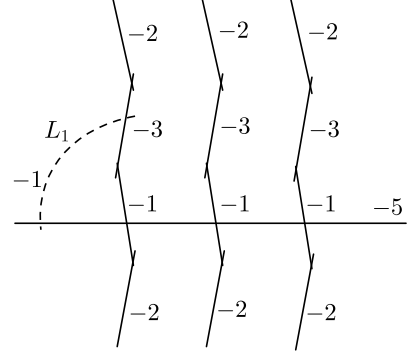
 FIGURE 14. Type \mathcal{Q}_4 .

 FIGURE 15. Type \mathcal{Q}_3 .

Therefore, we may assume that at least two numbers t_j are non-zero, say $t_1 \geq t_2 \geq 1$. Let $\ell_1, \ell_2 \subseteq \mathbb{P}^2$ be the lines tangent to \bar{E} at q_1, q_2 and let $\ell_{12} \subseteq \mathbb{P}^2$ be the line joining q_1 and q_2 . For $j \in \{1, 2\}$, the number $(\ell_j \cdot \bar{E})_{q_j}$ is the sum of at least two initial terms of the multiplicity sequence of $q_j \in \bar{E}$, so, since \bar{E} is a quintic, $(\ell_j \cdot \bar{E})_{q_j} = 4$. If $\ell_j = \ell_{12}$ then $\ell_{12} \cdot \bar{E} \geq 4 + 2 = 6 > \deg \bar{E}$, which is false. Hence, ℓ_1, ℓ_2 and ℓ_{12} are distinct and $\{p\} := \ell_{12} \cap \bar{E} \setminus \{q_1, q_2\}$ is a point where ℓ_{12} and \bar{E} meet transversally. Denote by σ the blowup at q_1, q_2 and their infinitely near points on the proper transforms of \bar{E} . For $j \in \{1, 2\}$ let q'_j be the point infinitely near to q_j on $\sigma_*^{-1}\bar{E}$. The pencil of conics generated by $\ell_1 + \ell_2$ and $2\ell_{12}$ gives a morphism $\sigma_*^{-1}\bar{E} \rightarrow \mathbb{P}^1$ of degree $2 \deg \bar{E} - (4 + 4) = 2$, which is ramified at the preimages of p, q_3, \dots, q_c and at q'_j for every $j \in \{1, 2\}$ such that $t_j \geq 2$. By the Hurwitz formula, there are exactly two ramification points. If $t_1 \geq 2$ then we get $c = 2$ and $t_2 = 1$, so $t_1 = 4$ by (3.4), contrary to our claim. Hence, $t_1 = t_2 = 1$ and we get $c = 3$. Now $t_3 = 1$ by (3.4), so \bar{E} is of type \mathcal{Q}_3 , see Figure 15. Note that $E^2 = -5$ by Lemma 2.10. \square

By Lemma 3.12(f), we are now left with the cases $n = 2$ and $n = 3$. By definition, the morphism ψ contracts n curves not contained in D_0 . Denote them by A, A' and, if $n = 3$, by A'' . By Lemma 2.20(a) they are almost log exceptional on $(X_0, \frac{1}{2}D_0)$. By Lemma 3.12(c),(g), $\psi^+(E_0)$ is either a cuspidal cubic or a conic or a line. In the following propositions we treat these cases separately.

Proposition 3.14. If $n = 2$ and $\psi^+(E_0)$ is a cubic then \bar{E} is of type \mathcal{FZ}_2 (see Figure 16).

Proof. Lemma 3.12(a),(f) implies that $D_{\min} - \psi^+(E_0)$ is a union of two lines, say ℓ_1, ℓ_2 . By Lemma 3.12(c), $\psi^+(E_0)$ is a cuspidal cubic, so it has a unique singular point, which is an ordinary cusp. Lemma 3.12(e) gives

$$\#(\ell_1 + \ell_2) \cap \psi^+(E_0) = 2n - \#\ell_1 \cap \ell_2 = 3,$$

so, say, $\#\ell_1 \cap \psi^+(E_0) = 2$ and $\#\ell_2 \cap \psi^+(E_0) = 1$. Write $\ell_1 \cap \psi^+(E_0) = \{p_1, p_2\}$, where $(\ell_1 \cdot \psi^+(E_0))_{p_1} = 1$ and $(\ell_1 \cdot \psi^+(E_0))_{p_2} = 2$. We claim that

$$(3.5) \quad \ell_1 = \psi^+(C_1), \quad \ell_2 = \psi^+(C_2) \quad \text{and} \quad \psi^+(A) = \ell_1 \cap \ell_2, \quad \psi^+(A') = \{p_1\}.$$

Lemma 3.2(e) implies that $(\psi^+)^{-1}\ell_1$ meets E_0 , so by Lemma 3.12(b) $(\psi^+)^{-1}\ell_1 = C_j$ for some $j \in \{1, \dots, c\}$, say, $j = 1$. The point p_1 is a center of ψ^+ , since otherwise $C_1 \cdot E_0 = (\ell_1 \cdot \psi^+(E_0))_{p_1} = 1$, which is false. Say that $\psi^+(A') = \{p_1\}$. By Lemma 3.2(e)

$$(\psi^+)^{-1}(p_1) = A' + \Delta_{A'},$$

where $\Delta_{A'}$ is a (-2) -twig meeting C_1 . Since $(\ell_1 \cdot \psi^+(E_0))_{p_1} = 1$, A' meets $\text{tip}^+(\Delta_{A'})$. It follows that $\psi_{A'}$ touches C_1 once. But $\psi^+(C_1)^2 \geq 1 = C_1^2 + 2$, so ψ^+ touches C_1 at least twice. Hence,

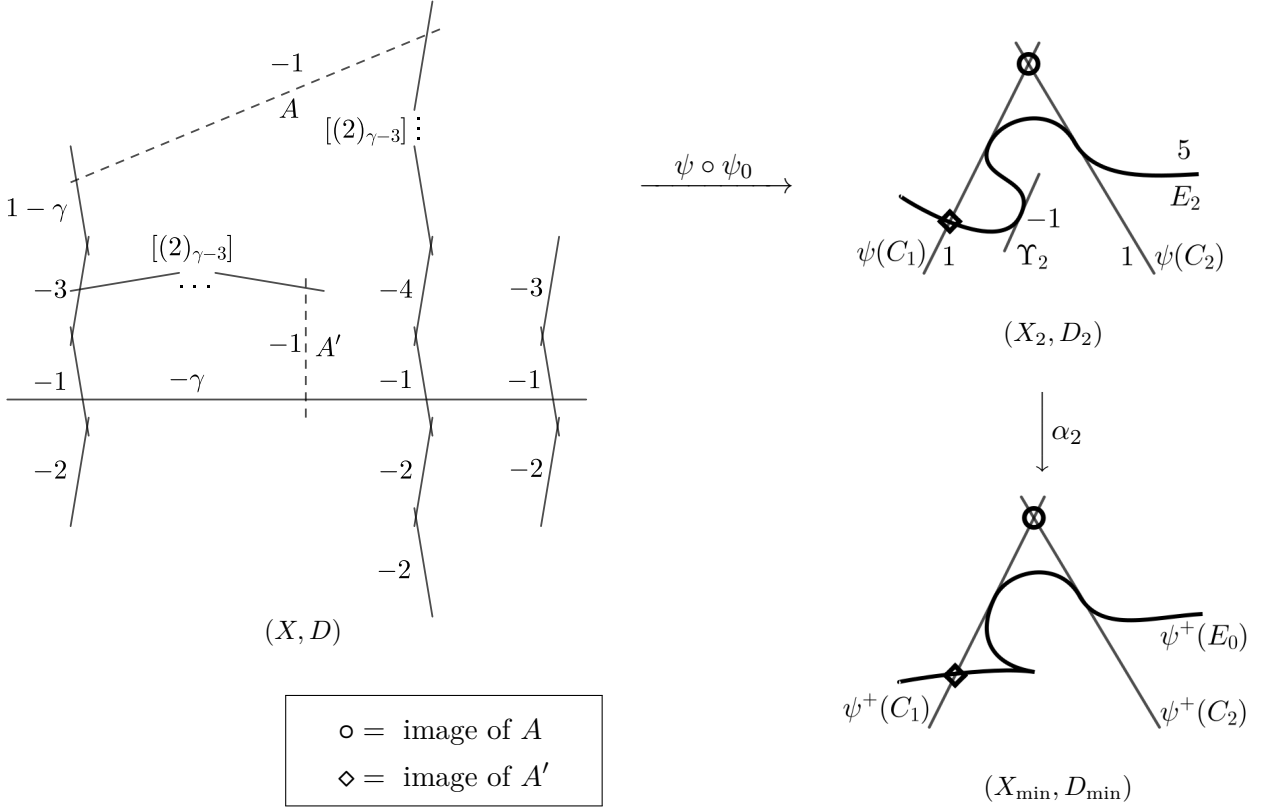
 FIGURE 16. Type $\mathcal{FZ}_2(\gamma)$, $\gamma \geq 4$.

$\psi^+(A) \subseteq \psi^+(C_1)$. As a consequence, $\ell_1 \cap \ell_2 = \psi^+(A)$, so, since $n = 2$, $\ell_2 \cap \psi^+(E_0)$ is not a center of ψ^+ . Thus $(\psi^+)^{-1}_* \ell_2 \cdot E_0 = \ell_2 \cdot \psi^+(E_0) = 3$, so $(\psi^+)^{-1}_* \ell_2 = C_2$. This proves (3.5). It follows that

$$\tau_1 = (\ell_1 \cdot \psi^+(E_0))_{p_2} = 2 \quad \text{and} \quad \tau_2 = \ell_2 \cdot \psi^+(E_0) = 3.$$

Since the components of D_{\min} meet transversally at $\psi^+(A)$, $\psi^+(A')$, these points are not touched by α_2^{-1} , hence the only center of α_2 is the ordinary cusp of $\psi^+(E_0)$. Thus

$$\text{Exc } \psi = \text{Exc } \psi^+ - \Upsilon_0 = A + A' + D_0 - \Upsilon_0 - (\psi^+)^{-1}_* D_{\min} = A + A' + Q_1 - C_1 + Q_2 - C_2,$$

and hence

$$\text{Exc } \psi_A = \text{Exc } \psi - \text{Exc } \psi_{A'} = (Q_1 - C_1 - \Delta_{A'}) + A + (Q_2 - C_2).$$

Lemma 2.17(d) implies now that $Q_1 - C_1 - \Delta_{A'}$ and $Q_2 - C_2$ are zero or twigs of D_0 . Because Q_1 meets A , the cusp $q_1 \in \bar{E}$ is not semi-ordinary, so since $\tau_1 = 2$, by Lemma 2.7(c) we have $Q_1 - C_1 \neq \Delta_{A'}$. Because Q_1 and Q_2 contract to smooth points, we obtain $Q_1 = [(2)_{t_1}, \#\Delta_{A'} + 2, 1, (2)_{\#\Delta_{A'}}]$ and $Q_2 = [(2)_{t_2}, 1]$. Since $\Delta_{A'} \neq 0$, the contractibility of $\text{Exc } \psi_A = [\#\Delta_{A'} + 2, (2)_{t_1}, 1, (2)_{t_2}]$ to a smooth point gives $t_1 = 0$ and $t_2 = \#\Delta_{A'} \geq 1$.

Thus $Q_1 = [t_2 + 2, 1, (2)_{t_2}]$ and $Q_2 = [(2)_{t_2}, 1]$. Recall that $\tau_1 = 2$, $\tau_2 = 3$ and, by Lemma 3.12(b), $s_1 = s_2 = 1$. Since $\psi^+(E_0)$ has one ordinary cusp, $c = 3$ and $q_3 \in \bar{E}$ is ordinary. Therefore, \bar{E} is of type $\mathcal{FZ}_2(\gamma)$, where $\gamma = t_2 + 3 \geq 4$, see Figure 16. Note that $E^2 = -\gamma$ by Lemma 2.10. \square

Proposition 3.15. If $n = 2$ and $\psi^+(E_0)$ is a conic then \bar{E} is of type \mathcal{H} (see Figure 17).

Proof. Lemma 3.12(a),(f) implies that $D_{\min} - \psi^+(E_0)$ is a union of a line ℓ and a conic m . Hence, D_{\min} is as in Lemma 3.12(h). We now proceed as in the proof of Proposition 3.14. Write $m \cap \psi^+(E_0) = \{p_1, p_2\}$, where $(m \cdot \psi^+(E_0))_{p_1} = 1$ and $(m \cdot \psi^+(E_0))_{p_2} = 3$. We claim that

$$(3.6) \quad m = \psi^+(C_1), \quad \ell = \psi^+(C_2), \quad \text{and} \quad \psi^+(A) = m \cap \ell, \quad \psi^+(A') = \{p_1\}.$$

Lemma 3.2(e) implies that $(\psi^+)^{-1}_* m$ meets E_0 , so by Lemma 3.12(b) $(\psi^+)^{-1}_* m = C_j$ for some $j \in \{1, \dots, c\}$, say, $j = 1$. The point p_1 is a center of ψ^+ , since otherwise $C_1 \cdot E_0 = (\ell_1 \cdot \psi^+(E_0))_{p_1} = 1$, which is false. Say that $\{p_1\} = \psi^+(A')$. By Lemma 3.2(e)

$$(\psi^+)^{-1}(p_1) = A' + \Delta_{A'},$$

where $\Delta_{A'}$ is a (-2) -twig meeting C_1 . Because $(m \cdot \psi^+(E_0))_{p_1} = 1$, A' meets $\text{tip}^+(\Delta_{A'})$. It follows that $\psi_{A'}$ touches C_1 once. But $\psi^+(C_1)^2 \geq 1 = C_1^2 + 2$, so ψ^+ touches C_1 at least twice. Hence,

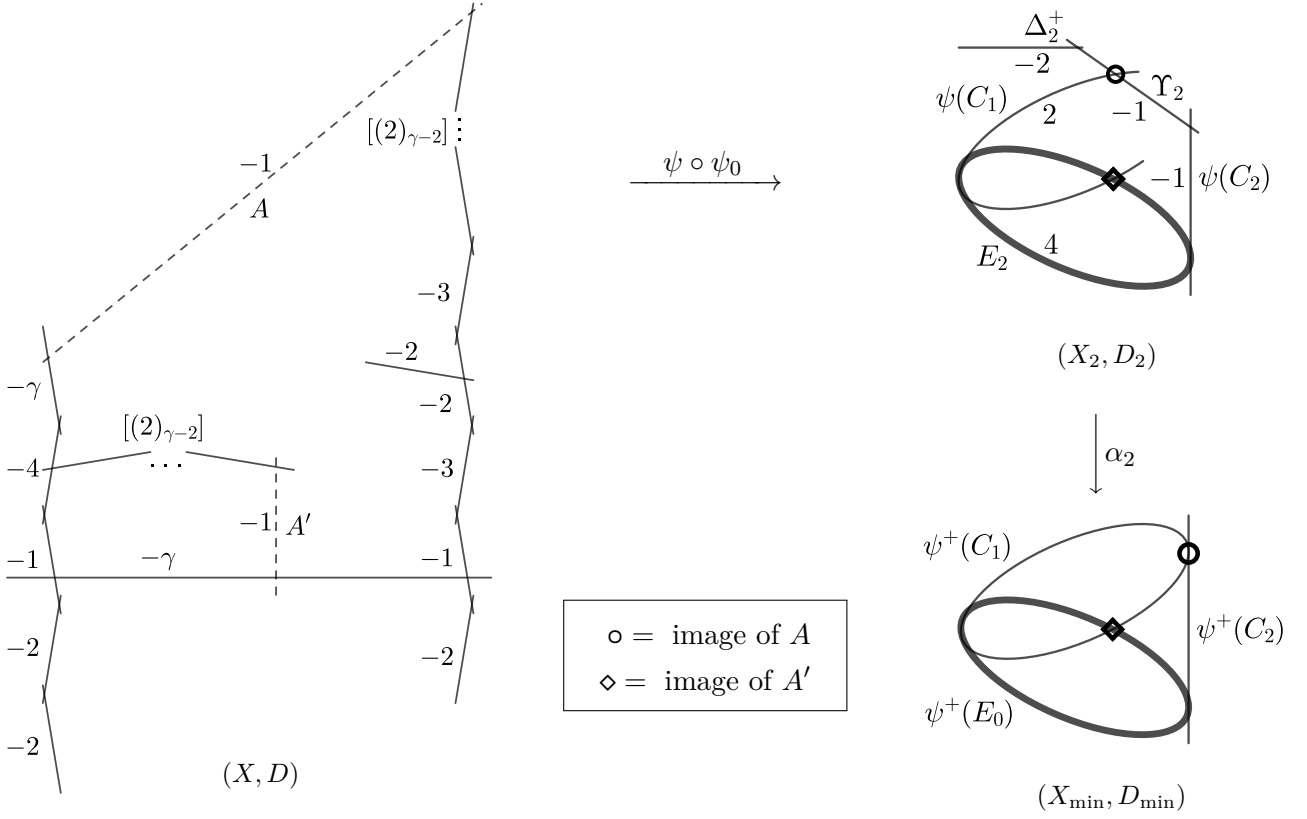
 FIGURE 17. Type $\mathcal{H}(\gamma)$, $\gamma \geq 3$.

$\psi^+(A) \subseteq \psi^+(C_1)$. As a consequence, $m \cap \ell = \psi^+(A)$, so, since $n = 2$, $\ell \cap \psi^+(E_0)$ is not a center of ψ^+ . Thus $(\psi^+)^{-1}_* \ell \cdot E_0 = \ell \cdot \psi^+(E_0) = 2$, so $(\psi^+)^{-1}_* \ell = C_2$. This proves (3.6). It follows that

$$\tau_1 = (m \cdot \psi^+(E_0))_{p_2} = 3, \quad \tau_2 = \ell \cdot \psi^+(E_0) = 2.$$

We have $\alpha_2^{-1}(\psi^+(A)) = [1, 2] \subseteq \Upsilon_2 + \Delta_2^+$, because $(m \cdot \ell)_{\psi^+(A)} = 2$ and $D_2 - E_2$ is snc. The latter inclusion is in fact an equality, because $\psi^+(A')$ is not a center of α_2 and $\Upsilon_0 + \Delta_0^+ = 0$, as $\psi^+(E_0)$ is smooth. Put $U = \psi_*^{-1} \Upsilon_2$, $\Delta_U = \psi_*^{-1} \Delta_2^+$. By Lemma 2.17(g) Δ_U is a (-2) -tip of D_0 meeting U . We have $\psi(U) \cap \psi(C_1) = \psi(A)$, because otherwise U meets C_1 and

$$m^2 = \psi(C_1)^2 + 2 = \psi_{A'}(C_1)^2 + 2 = C_1^2 + 3 = 2,$$

which is false, as $m^2 = 4$. The divisor $D_0 \wedge \text{Exc } \psi$ equals

$$D_0 \wedge \text{Exc } \psi^+ - \psi_*^{-1}(\Upsilon_2 + \Delta_2^+) = D_0 - (\psi^+)^{-1}_* D_{\min} - U - \Delta_U = Q_1 - C_1 - U - \Delta_U + Q_2 - C_2,$$

so

$$\text{Exc } \psi_A = \text{Exc } \psi - \text{Exc } \psi_{A'} = (Q_1 - C_1 - \Delta_{A'}) + A + (Q_2 - C_2 - U - \Delta_U).$$

Lemma 2.17(d) implies that $V_1 := Q_1 - C_1 - \Delta_{A'}$ and $V_2 := Q_2 - C_2 - U - \Delta_U$ are zero or twigs of D_0 meeting C_1 and U , respectively. Because Q_1 contracts to a smooth point and $\Delta_{A'} \neq 0$, we obtain $V_1 = T_1 = [(2)_{t_1}, \#\Delta_{A'} + 2]$. If $t_1 \neq 0$ then (3.2) holds for $j = 1$, so A' meets Q_2 by Lemma 3.5(g), which is false, because $\{p_1\} = \psi^+(A') \not\subseteq \ell$. Thus $t_1 = 0$. The contractibility of Q_2 to a smooth point implies that $V_2 + [1] + \Delta_U$ contracts to a smooth point, so either $V_2 = 0$ or $V_2 = T_2 = [(2)_{t_2}, 3]$. Eventually, since $\#\Delta_{A'} > 0$, the contractibility of $\text{Exc } \psi_A$ to a smooth point gives $V_2 \neq 0$ and $t_2 = \#\Delta_{A'} \geq 1$.

Thus $Q_1 = [t_2 + 2, 1, (2)_{t_2}]$ and Q_2 is a fork with maximal twigs $T_2 = [(2)_{t_2}, 3]$, $\Delta_U = [2]$ and $C_1 = [1]$. Because Q_2 contracts to a smooth point, $B_2^2 = -2$. Recall that $\tau_1 = 3$, $\tau_2 = 2$ and that, by Lemma 3.12(b), $s_1 = s_2 = 1$. We have $c = 2$ since $\psi^+(E_0)$ is smooth. Therefore, \bar{E} is of type $\mathcal{H}(\gamma)$, where $\gamma = t_2 + 2 \geq 3$, see Figure 17. Note that $E^2 = -\gamma$ by Lemma 2.10. \square

Proposition 3.16. If $n = 2$ and $\psi^+(E_0)$ is a line then \bar{E} is of type \mathcal{J} (see Figure 18).

Proof. Lemma 3.12(a),(d),(f) implies that $D_{\min} - \psi^+(E_0)$ is a sum of two conics m_1, m_2 . Hence, D_{\min} is as in Lemma 3.12(h). In particular, $m_1 \cap m_2 = \{p_1, p_2\}$, where $(m_1 \cdot m_2)_{p_1} = 1$ and $(m_1 \cdot m_2)_{p_2} = 3$.

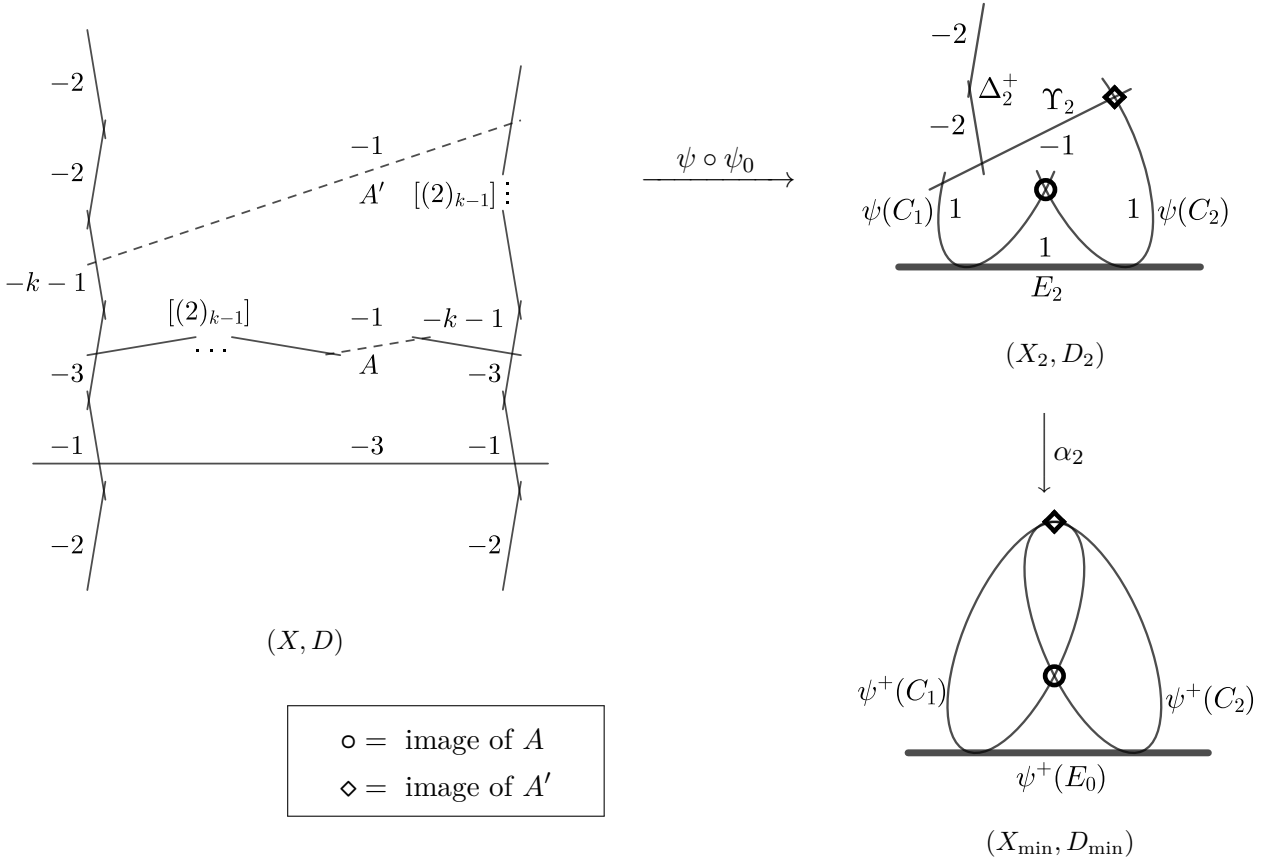
 FIGURE 18. Type $\mathcal{J}(k)$, $k \geq 2$ for $n = 2$ (cf. Figure 6 for $\mathcal{J}(2)$).

Because $D_2 - E_2$ is snc, the point p_2 is a center of α_2 and $\alpha_2^{-1}(p_2) = [1, 2, 2] \subseteq \Upsilon_2 + \Delta_2^+$. Let U be the component of $(\psi^+)^{-1}(p_2)$ such that $\psi(U) \subseteq \Upsilon_2$ and let Δ_U be the connected component of $\psi_*^{-1}\Delta_2^+$ meeting U . We have $\Delta_U = [2, 2]$ by Lemma 2.17(g).

Lemma 3.12(c) implies that $q_1 \in \bar{E}$ is not semi-ordinary, so $C_1 \not\subseteq \text{Exc } \psi^+$, hence $\psi^+(C_1) = m_j$ for some $j \in \{1, 2\}$. By symmetry we may assume $m_1 = \psi^+(C_1)$. We claim that $m_2 = \psi^+(C_2)$. Suppose the contrary. Then $(\psi^+)_*^{-1}m_2 \cdot E_0 < m_2 \cdot \psi^+(E_0)$, so the unique point of $\psi^+(E_0) \cap m_2$ is a center of ψ^+ , say, $\psi^+(E_0) \cap m_2 = \psi(A)$. By Lemma 3.2(e) the preimage on X_0 of $\psi^+(A)$ is a chain $A + \Delta_A$ for some $\Delta_A \subseteq \Delta_0$ meeting $(\psi^+)_*^{-1}m_2$. Because $(m_2 \cdot \psi^+(E_0))_{\psi^+(A)} > 1$, A meets $\text{tip}^-(\Delta_A)$ and $\#\Delta_A = m_2 \cdot \psi^+(E_0) = 2$. The curve $\psi(U) \subseteq \Upsilon_2$ meets $D_2 - \psi_*\Delta_U$ exactly in two points, belonging to $(\alpha_2^{-1})_*m_1 = \psi(C_1)$ and $(\alpha_2^{-1})_*m_2$, respectively. One of these points is $\psi(A')$, and the other is not a center of ψ (see Lemma 3.2(a)). If $\psi(A') \not\subseteq \psi(C_1)$ then $m_1^2 = C_1^2 + 3 = 2$, which is impossible. Hence, $\psi(A') \subseteq (\alpha_2^{-1})_*m_2$, so $((\psi^+)_*^{-1}m_2)^2 = m_2^2 - 3 - 2 = -1$, which implies that $(\psi^+)_*^{-1}m_2 = C_2$. But $(\psi^+)_*^{-1}m_2$ does not meet E_0 ; a contradiction.

Therefore, $m_j = \psi^+(C_j)$ for $j \in \{1, 2\}$. Since $\#(m_j \cap \psi^+(E_0)) = 1$, it follows that $\tau_j = (\psi^+)_*^{-1}m_j \cdot E_0 = m_j \cdot \psi^+(E_0) = 2$ and that the centers of ψ^+ are p_1 and p_2 .

Recall that $\psi(U) \subseteq \Upsilon_2$, so $\psi(U)$ meets $D_2 - \psi_*(U + \Delta_U)$ in two points, namely $\psi(U) \cap \psi(C_j)$ for $j \in \{1, 2\}$. Exactly one of these points is a center of ψ . By symmetry we may assume that it is $\psi(U) \cap \psi(C_2)$. Then U meets C_1 , so $U + \Delta_U \subseteq Q_1$. We have

$$D_0 \wedge \text{Exc } \psi = (Q_1 - C_1 - U - \Delta_U) + (Q_2 - C_2).$$

Lemma 2.17(d) implies that Q_2 is a chain and Q_1 is either a chain or a fork with branching component U . Put $k = -U^2 - 1 \geq 1$.

Let $A \subseteq \text{Exc } \psi$ be the almost log exceptional curve meeting T_2 . Lemma 2.17(d) implies that $W := \text{Exc } \psi_A - A - T_2$ is zero or a twig of D_0 . Because $\psi^+(A) \subseteq m_1$, we have $W \subseteq Q_1$. We claim that $W \neq 0$ and $W \neq T_1$. If $W = 0$ then $T_2 \subseteq \Delta_0$, so $T_2^0 = C_1$ and by Lemma 2.7(c) $q_2 \in \bar{E}$ is semi-ordinary, which is false. Thus $W \neq 0$. Suppose that $W = T_1$. Then A meets D_0 only in $\text{tip}^+(T_j)$ for $j \in \{1, 2\}$. It follows that $\pi_0(A) \cap \bar{E} = \{q_1, q_2\}$, the numbers $(\pi_0(A) \cdot \bar{E})_{q_j}$ are equal to the multiplicities μ_j of $q_j \in \bar{E}$ and $\pi_0(A)^2 = A^2 + 2 = 1$. Hence, $\deg \bar{E} = \mu_1 + \mu_2$. Because $s_j = 1$, the multiplicity sequence of q_j consists of some number of terms divisible by $\tau_j = 2$ and the sequence $(1, 1)$ at the end. In particular,

$2|\mu_j$, so $2|\deg \bar{E}$ and Lemma 2.10(b) implies that $2|E^2$. But $E^2 = E_0^2 - (\tau_1 + \tau_2) = \psi^+(E_0)^2 - 4 = -3$; a contradiction. Therefore, $W \neq T_1$.

The contractibility of Q_1 to a smooth point implies that $W = [(2)_{k-1}]$, so $k \geq 2$, and that W meets C_1 . Since $\psi_{A'}$ does not touch C_1 , we have $\psi_A(C_1)^2 = m_1^2 - 3 = 1 = C_1^2 + 2$, so ψ_A touches C_1 twice, which implies that $\text{Exc } \psi_A = [(2)_{k-1}, 1, k+1]$. Hence, $T_2 = [k+1]$. Because Q_2 contracts to a smooth point, we get $Q_2 = [k+1, 1, (2)_{k-1}]$. The morphism $\psi_{A'}$ touches C_2 once, because $\psi_{A'}(C_2)^2 = \psi(C_2)^2 - 1 = m_2^2 - 4 = 0 = C_2^2 + 1$. Hence, $\text{Exc } \psi_{A'} = A' + T_2'$. It follows that $Q_1 = \Delta_U + U + C_1 + W = [2, 2, k+1, 1, (2)_{k-1}]$.

Recall that for $j \in \{1, 2\}$, we have $\tau_j = m_j \cdot \psi^+(E_0) = 2$ and $s_j = 1$ by Lemma 3.12(b). Also, $c = 2$, because $\psi^+(E_0)$ is smooth. It follows that \bar{E} is of type $\mathcal{J}(k)$, see Figure 18. Note that $E^2 = -3$ by Lemma 2.10. \square

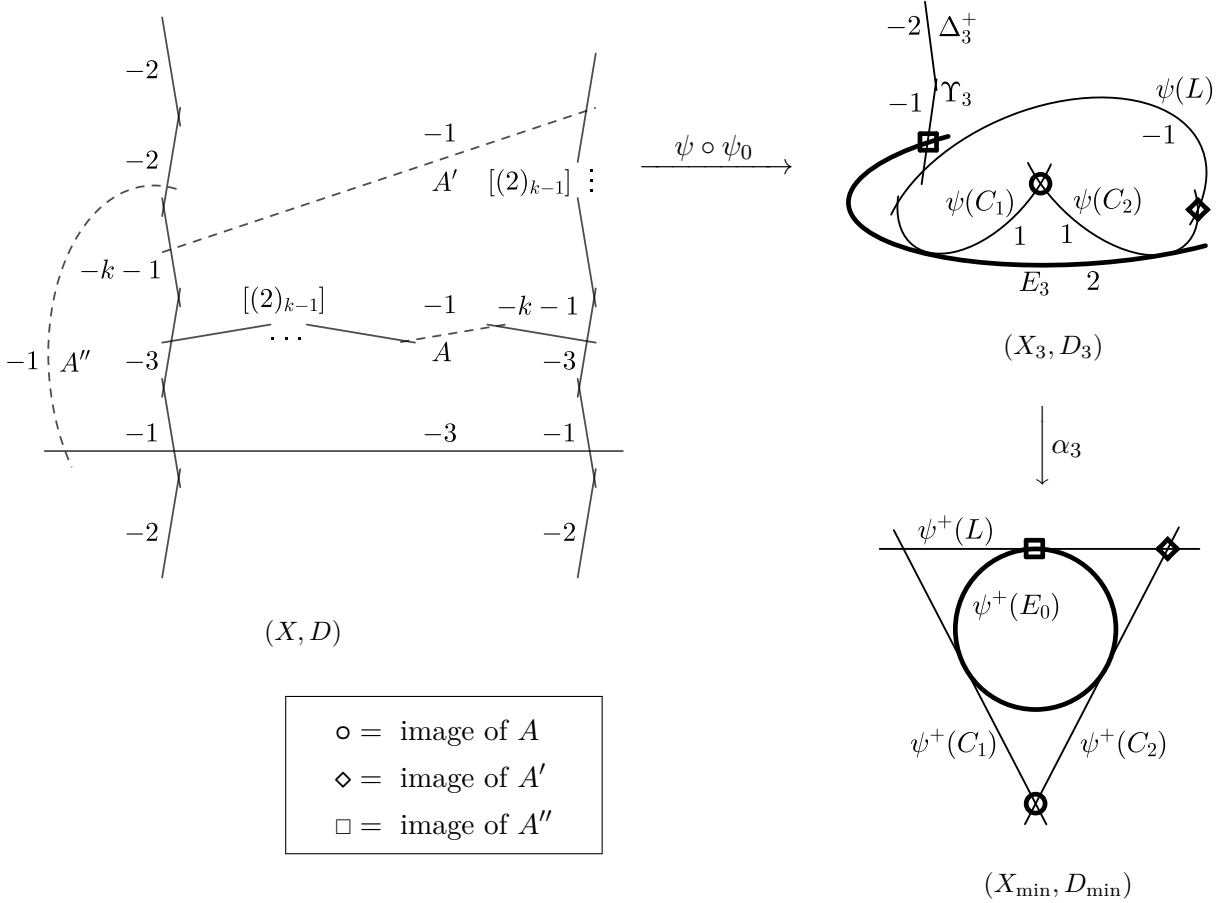

FIGURE 19. Type $\mathcal{J}(k)$, $k \geq 2$ for $n = 3$ (cf. Figure 6 for $\mathcal{J}(2)$).

Proposition 3.17. If $n = 3$ then \bar{E} is of type \mathcal{J} (see Figure 19).

Proof. Lemma 3.12(a),(e) implies that D_{\min} is a conic m inscribed in a triangle $\ell_1 + \ell_2 + \ell_3$. We claim that $m = \psi^+(E_0)$. Suppose not. Then $(\psi^+)^{-1}m$ is contained in $Q_1 + \dots + Q_c$, so it meets every other component of $D_0 - E_0$ at most once. Hence the two points $m \cap (D_{\min} - \psi^+(E_0) - m)$ are centers of ψ^+ . Moreover, since E_0 contains no point of normal crossings on D_0 , the two points $\psi^+(E_0) \cap (D_{\min} - \psi^+(E_0) - m)$ are centers of ψ^+ , too. But then $n \geq 4$; a contradiction.

Suppose that $\ell_j = \psi^+(C_j)$ for $j \in \{1, 2, 3\}$. Then at each center of ψ^+ two components of D_{\min} meet transversally, so from the definition of Υ_3 (see Figure 4) we infer that $\psi^+ = \psi$. Lemma 2.17(d) implies that $\psi^*(D_n - E_n)_{\text{red}}$ is circular, and hence $(\pi_0)_*\psi^*(D_n - E_n)_{\text{red}}$ is circular, too. The latter equals $\pi_0(A) + \pi_0(A') + \pi_0(A'')$ and consists of three smooth components meeting transversally in three points, so it is again a triangle. It follows that π_0 touches A, A', A'' twice each, so they meet each Q_j only in its first component. Since $\psi^*(D_0 - E_0)_{\text{red}}$ is circular, this is possible only if $Q_j = C_j$ for $j \in \{1, 2, 3\}$. But then, since $\tau_j = \psi^+(E_0) \cdot \psi^+(C_j) = 2$, every $q_j \in \bar{E}$ is ordinary; a contradiction.

It follows that some ℓ_k , say ℓ_3 , is not the image of C_j for any $j \in \{1, \dots, c\}$. We now determine the centers of ψ^+ . By Lemma 3.12(b), $L := (\psi^+)^{-1}\ell_3$ does not meet E_0 . In particular, $\ell_3 \cap m$ is a center

of ψ^+ , say $\ell_3 \cap \mathfrak{m} = \psi^+(A'')$. Lemma 3.2(e) implies that $(\psi^+)^{-1}(\ell_3 \cap \mathfrak{m})$ is a chain $A'' + \Delta_{A''}$, where $\Delta_{A''} \subseteq \Delta_0$ meets L . Because $(\psi^+(L) \cdot \mathfrak{m})_{\psi^+(A'')} = 2$, A'' meets $\text{tip}^-(\Delta_{A''})$ and $\#\Delta_{A''} = 2$. Since the contraction of $A'' + \Delta_{A''}$ touches L twice and $L^2 + 2 \leq 0 < \ell_3^2$, the line ℓ_3 contains another center of ψ^+ , say $\ell_2 \cap \ell_3 = \psi^+(A')$. Because ψ^+ touches ℓ_1 , we have $\psi^+(A) \subseteq \ell_1$. If $\psi^+(A) \subseteq \mathfrak{m}$ then arguing as above for $\psi^+(A') \subseteq \ell_3$ we obtain that ℓ_1 contains another center of ψ^+ , which is false. It follows that for $j \in \{1, 2\}$ the curve $(\psi^+)^{-1}_* \ell_j$ meets E_0 , so by Lemma 3.12(b) we have, say, $\ell_j = \psi^+(C_j)$ for $j \in \{1, 2\}$. Because C_1 and C_2 are disjoint, the common point of their images is a center of ψ^+ , so $\ell_1 \cap \ell_2 = \psi^+(A)$. Moreover, we get $\tau_j = C_j \cdot E_0 = \ell_j \cdot \mathfrak{m} = 2$ for $j \in \{1, 2\}$ and $L \cdot C_1 = \ell_3 \cdot \ell_1 = 1$.

To describe the shape of Q_1 note first that the point $\psi^+(A'')$ is the only center of α_3 . Indeed, since $\psi^+(E_0)$ is smooth, the centers of α_3 are contained in the image of $\text{Exc } \psi$, and the points $\psi^+(A)$, $\psi^+(A')$ are not centers of α_3 , because they are nc-points of D_{\min} . It follows that

$$D_0 \wedge \text{Exc } \psi = (Q_1 - C_1 - L - \Delta_{A''}) + (Q_2 - C_2).$$

Lemma 2.17(d) implies that Q_2 is a chain and Q_1 is either a chain or a fork with branching component L . Suppose that $T_1 \subseteq \text{Exc } \psi$. Then, because Q_1 contracts to a smooth point, $\Delta_{A''} \subseteq T_1'$ and $T_1 = [(2)_{t_1}, \#\Delta_{A''} + 2] = [(2)_{t_1}, 4]$. Hence

$$\pi_0(A'')^2 = (A'')^2 + 2 + 4(t_1 + 1) = 4t_1 + 5.$$

In particular, $t_1 \neq 0$, so (3.2) holds for $j = 1$ and Lemma 3.5(g) implies that A'' meets Q_2 ; a contradiction. It follows that $\Delta_{A''} \subseteq T_1$. This inclusion is strict, because otherwise $Q_1 = C_1 + \Delta_{A''}$, which is false. Hence $T_1 = \Delta_{A''} + L$, so Q_1 is a chain, and because it contracts to a smooth point, $Q_1 = [2, 2, k + 1, 1, (2)_{k-1}]$, where $k = -L^2 - 1 \geq 1$. We have $k \geq 2$, because otherwise Lemma 2.7(c) implies that $q_1 \in \bar{E}$ is semi-ordinary, which is false.

We now describe the shape of Q_2 . Because $\psi^+(A') \subseteq \ell_3$, the curve L meets $\text{Exc } \psi_{A'}$. The divisor $\text{Exc } \psi^+$ has a negative definite intersection matrix, so $A' \cdot (\Delta_{A''} + A'') = 0$. Since $\Delta_{A''}$ is the unique twig of D_0 meeting L , it follows from Lemma 2.17(d) that A' meets L and hence $\text{Exc } \psi_{A'} - A'$ is a (-2) -twig. If $\text{Exc } \psi_{A'} - A' = T_2$ then by Lemma 2.7(c) $q_2 \in \bar{E}$ is semi-ordinary, which is false. Thus $\text{Exc } \psi_{A'} = A' + T_2'$. Eventually, $T_2' = [(2)_{k-1}]$, because $\psi_{A'}$ touches L exactly k times. Indeed,

$$\psi_{A'}(L)^2 - L^2 = \psi(L)^2 + k + 1 = \psi^+(L)^2 + k - 1 = k.$$

The contractibility of Q_2 to a smooth point implies that $T_2 = [(2)_{t_2}, k + 1]$. We have $t_2 = 0$, for otherwise (3.2) holds for $j = 2$ and by Lemma 3.5(g) A'' meets $\text{tip}^+(T_1')$, which is false. Hence, $Q_2 = [k + 1, 1, (2)_{k-1}]$.

Recall that for $j \in \{1, 2\}$, $s_j = 1$ by Lemma 3.12(b) and $\tau_j = C_j \cdot E_0 = \ell_j \cdot \mathfrak{m} = 2$. We have $c = 2$ since $\psi^+(E_0)$ is smooth. Therefore, \bar{E} is of type $\mathcal{J}(k)$, see Figure 19. Note that $E^2 = -3$ by Lemma 2.10. \square

Remark 3.18 (Uniqueness of the process of almost minimalization). As we have indicated in Example 2.22, a rational cuspidal curve of type \mathcal{J} is obtained both in Propositions 3.16 and 3.17, which corresponds to two possible choices of the process ψ of almost minimalization. Our proof shows that for every other type in Definition 1.3 this process (as defined in Section 2D) is unique.

4. EXISTENCE AND UNIQUENESS

In this Section we finish the proof of Theorem 1.2 by proving that each type in the list of Definition 1.3 is realized by a planar rational cuspidal curve which is unique up to a projective equivalence, and that the complement of such curve is a surface of log general type which satisfies (2.9). We begin with a proof of condition (2.9) in Section 4A. The nonexistence of \mathbb{C}^{**} -fibrations follows from [PP17, Theorem 1.3], because the type of \bar{E} is not listed in loc. cit. and we have $\kappa(\mathbb{P}^2 \setminus \bar{E}) = 2$ by Lemma 4.1. An independent proof of this fact is given in Section 4E. Existence and uniqueness of curves of types \mathcal{FZ}_2 , \mathcal{FE} and \mathcal{H} is either established or can be inferred from results in the literature, see Section 4C. This is also true for types \mathcal{Q}_3 and \mathcal{Q}_4 , but we give an independent geometric argument in Section 4B. For the remaining types \mathcal{I} and \mathcal{J} we prove the existence and uniqueness in Section 4D by reverting the process of almost minimalization constructed in Section 3.

In Section 5A we prove Theorem 1.4, which implies that all curves of types listed in Definition 1.3 are closures of images of some proper injective morphisms $\mathbb{C}^* \rightarrow \mathbb{C}^2$. The latter morphisms, which we call *singular embeddings*, are classified in [BZ10] under some regularity assumptions. In Remarks 4.11, 4.12(a),(b),(c) and 4.17(a) we explain how to obtain curves as in Definition 1.3 from [BZ10].

In Section 3 we were working mostly with the minimal weak resolution $\pi_0: (X_0, D_0) \rightarrow (\mathbb{P}^2, \bar{E})$. Here it will be more convenient to work with the minimal log resolution $\pi: (X, D) \rightarrow (\mathbb{P}^2, \bar{E})$. For $j \in \{1, \dots, c\}$

we denote by $Q'_j \subseteq D$ the reduced preimage of $q_j \in \bar{E}$. Its components are naturally ordered as exceptional divisors of the successive blowups in the decomposition of π^{-1} , see (2.3). In particular, the last component of Q'_j is the unique (-1) -curve in Q'_j , which we denote by C'_j . As in Section 2C, we put $E := (\pi^{-1})_* \bar{E}$. If \bar{E} is of one of the types in Definition 1.3 then the number E^2 , computed using Lemma 2.10, is given in Table 1. In particular, $E^2 \leq -3$. The weighted graph of D is shown in one of the Figures 12–18.

4A. The Kodaira–Iitaka dimension.

Lemma 4.1 (Complements are of log general type). If $\bar{E} \subseteq \mathbb{P}^2$ is of one of the types listed in Definition 1.3 then $\kappa(\mathbb{P}^2 \setminus \bar{E}) = 2$.

Proof. Suppose the contrary. We have $c \geq 2$, so [Wak78] implies that $\kappa(\mathbb{P}^2 \setminus \bar{E}) \geq 0$ and $c = 2$, hence \bar{E} is of type \mathcal{H} , \mathcal{I} or \mathcal{J} . By the Iitaka Easy Addition Theorem, $\mathbb{P}^2 \setminus \bar{E}$ has no \mathbb{C}^1 -fibration. Hence [Pal19, Proposition 2.6] implies that $\mathbb{P}^2 \setminus \bar{E}$ has a \mathbb{C}^* -fibration and by [PP17, Proposition 4.2] we can choose one without base points on X . Therefore, X has a \mathbb{P}^1 -fibration such that $F \cdot D = 2$ for any fiber F .

Suppose that D contains some fiber F . Because D contains no 0-curves, [Fuj82, 7.5] implies that $F_{\text{red}} = [2, 1, 2]$ and F meets $D - F_{\text{red}}$ only in the middle component. The latter equals C'_j for some $j \in \{1, 2\}$. Because $c = 2$, E meets $D - C'_j$, so $E \not\subseteq F$. Then Q'_1 contains F_{red} , so it is not negative definite; a contradiction. By Lemma 2.4 the horizontal part of D consists of two 1-sections and every fiber F has a unique component L_F not contained in D . We claim that $D_{\text{hor}} = C'_1 + C'_2$. Suppose that C'_j is vertical for some $j \in \{1, 2\}$. A fiber of a \mathbb{P}^1 -fibration cannot contain a branching (-1) -curve, so since $\beta_D(C'_j) = 3$, C'_j meets a section in D , hence C'_j has multiplicity one in a fiber. Thus C'_j is a tip of that fiber, so both sections in D meet C'_j . In particular, $D_{\text{hor}} \subseteq E + Q'_j$. But then C'_{3-j} is vertical and by the same argument we get $D_{\text{hor}} \subseteq E + Q'_{3-j}$, so $D_{\text{hor}} = E$; a contradiction. It follows that E is a component of some fiber F_E . Since $E \cdot (D - C'_1 - C'_2) = 0$, by the connectedness of D we get $F_E \wedge D = E$. As a consequence, $F_E = E + L_{F_E} = [1, 1]$, so $E^2 = -1$. This is a contradiction, because $E^2 \leq -3$. \square

Lemma 4.2 (Existence of special lines, cf. Theorem 1.4). Let $\bar{E} \subseteq \mathbb{P}^2$ be a rational cuspidal curve of one of the types listed in Definition 1.3 or in [PP17, Theorem 1.3, cf. Table 1]. We order the cusps $q_1, \dots, q_c \in \bar{E}$ in such a way that their multiplicity sequences (μ_j, μ'_j, \dots) , $j \in \{1, \dots, c\}$ form a non-increasing sequence in the lexicographic order. Denote by ℓ_{12} the line joining $q_1, q_2 \in \bar{E}$ and by ℓ_1 the line tangent to $q_1 \in \bar{E}$. Then

- (a) if \bar{E} is of type $\mathcal{FZ}_1, \mathcal{FZ}_2, \mathcal{FE}, \mathcal{A} - \mathcal{F}, \mathcal{H}$ or \mathcal{I} then $(\ell_{12} \cdot \bar{E})_{q_j} = \mu_j$ for $j \in \{1, 2\}$ and ℓ_{12} does not meet $\bar{E} \setminus \{q_1, q_2\}$,
- (b) if \bar{E} is of type $\mathcal{FZ}_1, \mathcal{FZ}_2, \mathcal{FE}, \mathcal{A} - \mathcal{D}, \mathcal{G}, \mathcal{H}, \mathcal{J}, \mathcal{Q}_3$ or \mathcal{Q}_4 then $(\ell_1 \cdot \bar{E})_{q_1} = \mu_1 + \mu'_1$ and ℓ_1 meets $\bar{E} \setminus \{q_1\}$ once and transversally, that is, $(\ell_1 \setminus \{q_1\}) \cdot (\bar{E} \setminus \{q_1\}) = 1$.

Proof. We check case by case that

$$\mu_1 + \mu_2 = \deg \bar{E} \text{ for types listed in (a) and } \mu_1 + \mu'_1 = \deg \bar{E} - 1 \text{ for types listed in (b)}$$

(for types listed in [PP17, Table 1] this was done in Section 4F loc. cit). The first equation implies (a). We have $(\ell_1 \cdot \bar{E})_{q_1} < \deg \bar{E}$. Indeed, otherwise ℓ_1 does not meet $\bar{E} \setminus \{q_1\}$, so $\ell_1 \cap (\mathbb{P}^2 \setminus \bar{E}) \cong \mathbb{C}^1$, which by Lemma 2.5 implies that $\kappa(\mathbb{P}^2 \setminus \bar{E}) < 2$, contrary to Lemma 4.1. Because the number $(\ell_1 \cdot \bar{E})_{q_1}$ is the sum of at least two initial terms of the multiplicity sequence of q_1 , the second equation implies (b). \square

We now study the Kodaira–Iitaka dimension of the divisor $K_X + \frac{1}{2}D$.

Lemma 4.3 (A criterion for $\kappa_{1/2} = -\infty$). Let D be a reduced effective divisor on a smooth projective surface X . Assume that there is a \mathbb{P}^1 -fibration of X such that for a fiber F we have

$$(4.1) \quad D \cdot F = 4 \text{ and there exists a } (-2)\text{-twig of } D \text{ with a horizontal component.}$$

Then $\kappa(K_X + \frac{1}{2}D) = -\infty$.

Proof. Suppose that $\kappa(K_X + \frac{1}{2}D) \geq 0$. Write \mathcal{P}, \mathcal{N} for the positive and negative part of the Zariski–Fujita decomposition of $K_X + \frac{1}{2}D$. Let $T = T_1 + \dots + T_m$ be a (-2) -twig of D , where T_k for $1 \leq k \leq m$ is the k -th component of T . We have $T_1 \cdot (K_X + \frac{1}{2}D) = -1 < 0$, so $T_1 \subseteq \text{Supp } \mathcal{N}$. If for some $1 \leq k < m$ we have $T_1 + \dots + T_k \subseteq \text{Supp } \mathcal{N}$ then

$$T_{k+1} \cdot \mathcal{N} = T_{k+1} \cdot (K_X + \frac{1}{2}D) - T_{k+1} \cdot \mathcal{P} = -T_{k+1} \cdot \mathcal{P} \leq 0,$$

so in fact $T_{k+1} \cdot \mathcal{N} < 0$, because $T_{k+1} \cdot T_k > 0$. It follows that $T_{k+1} \subseteq \text{Supp } \mathcal{N}$ and hence by induction $T \subseteq \text{Supp } \mathcal{N}$. Therefore,

$$0 < F \cdot \mathcal{N} = F \cdot (K_X + \frac{1}{2}D) - F \cdot \mathcal{P} = -F \cdot \mathcal{P};$$

a contradiction. \square

Proposition 4.4 (Complements are \mathbb{C}^{***} -fibered and have $\kappa_{1/2} = -\infty$). Let $\bar{E} \subseteq \mathbb{P}^2$ be a rational cuspidal curve of one of the types listed in Definition 1.3. Then the minimal log resolution (X, D) of (\mathbb{P}^2, \bar{E}) admits a \mathbb{P}^1 -fibration satisfying (4.1). In particular,

$$\kappa(K_X + \frac{1}{2}D) = \kappa(K_{X_0} + \frac{1}{2}D_0) = -\infty.$$

Proof. Assume that \bar{E} is of type \mathcal{Q}_3 or \mathcal{Q}_4 . Then $q_1 \in \bar{E}$ has multiplicity $\mu_1 = 2$, so the pullback of the pencil of lines through q_1 induces a \mathbb{P}^1 -fibration of X with $D \cdot F = \deg \bar{E} - (\mu_1 - 1) = 4$ for a fiber F . The first component of Q'_1 is a horizontal (-2) -tip of D , so this \mathbb{P}^1 -fibration satisfies (4.1).

Assume now that \bar{E} is of one of the remaining types. For $j \in \{1, 2\}$ denote by U_j the maximal twig of D containing the first component of Q'_j and by V_j the unique (-2) -twig of D meeting C'_j . If Q'_j is not a chain, we denote by B_j the branching component of Q'_j meeting U_j and by T'_j the unique twig of D meeting B_j which is disjoint from $U_j + V_j$ (cf. Notation 2.6).

Consider the types $\mathcal{FE}(\gamma)$, $\mathcal{FZ}_2(\gamma)$ and $\mathcal{H}(\gamma)$. By definition, we have $\gamma \geq 5$, $\gamma \geq 4$ and $\gamma \geq 3$, respectively. Let A, A' be the proper transforms on X of the lines ℓ_{12}, ℓ_1 from Lemma 4.2. We have $(A')^2 = A^2 = -1$, $A' \cdot D = A \cdot D = 2$, A meets D only in the first components of Q'_1 and Q'_2 and A' meets D only in E and in the second component of Q'_1 .

Consider the types $\mathcal{FE}(\gamma)$ and $\mathcal{H}(\gamma)$ (see Figures 12, 17). Then $T'_2 = [2]$ is disjoint from $C'_2 + A$ and $(Q'_2 - T'_2) + A + U_1$ is a chain $[2, 1, 3, 3, (2)_{\gamma-4}, 1, \gamma - 2]$ if \bar{E} is of type $\mathcal{FE}(\gamma)$ and $[2, 1, 3, 2, 3, (2)_{\gamma-2}, 1, \gamma]$ if \bar{E} is of type $\mathcal{H}(\gamma)$. This chain supports a fiber F of a \mathbb{P}^1 -fibration of X , which meets D_{hor} only once in C'_2 , once in B_2 and once in U_1 . Recall from Section 2B that for a vertical curve C we denote by $\mu(C)$ its multiplicity in the respective fiber. Here we have $\mu(C'_2) = 2$ and $\mu(B_2) = \mu(U_1) = 1$, so $F \cdot D = 4$. Because T'_2 is a horizontal (-2) -tip of D , this \mathbb{P}^1 -fibration satisfies (4.1).

Consider the type $\mathcal{FZ}_2(\gamma)$ (see Figure 16). Now

$$C'_2 + U_2 + A + U_1 + B_1 + T'_1 + A' = [1, 4, (2)_{\gamma-3}, 1, \gamma - 1, 3, (2)_{\gamma-3}, 1]$$

supports a fiber F of a \mathbb{P}^1 -fibration of X , which meets D_{hor} only twice in C'_2 , once in A' and once in B_1 . We have $\mu(C'_2) = \mu(B_1) = \mu(A') = 1$, so $F \cdot D = 4$. Because $\text{tip}^-(V_2)$ is a horizontal component of a (-2) -twig of D , this \mathbb{P}^1 -fibration satisfies (4.1).

Finally, consider the types \mathcal{I} and \mathcal{J} (see Figures 13, 18). Then $V_2 + C'_2 + E + C'_1 = [2, 1, 3, 1]$ supports a fiber F of a \mathbb{P}^1 -fibration of X , which meets D_{hor} only once in C'_2 and twice in C'_1 . We have $\mu(C'_2) = 2$ and $\mu(C'_1) = 1$, so $F \cdot D = 4$. Because $\text{tip}^-(V_1)$ is a horizontal component of a (-2) -twig of D , this \mathbb{P}^1 -fibration satisfies (4.1).

The last statement of the lemma follows from Lemma 4.3 and Proposition 2.15. \square

4B. Existence and uniqueness for types \mathcal{Q}_3 and \mathcal{Q}_4 .

The existence and uniqueness of curves of types \mathcal{Q}_3 and \mathcal{Q}_4 follows from the classification of rational planar quintics [Nam84, Theorem 2.3.10]. The proof sketched in loc. cit. is based on computations which are left as an exercise, so for completeness we give an independent geometric argument. We construct these curves from the Steiner tricuspidal quartic $\bar{C} = \mathcal{FZ}_1(4, 1)$ using quadratic Cremona transformations. We prove their projective uniqueness, too. The existence and uniqueness of \bar{C} itself follows, for example, from [FZ96, Theorem 3.5], but since we need its explicit form (4.2), we provide a direct argument.

Lemma 4.5 (The auxiliary quartic $\mathcal{FZ}_1(4, 1)$). Up to a projective equivalence there exists a unique pair $(\bar{C}, (p_1, p_2, p_3))$, where $\bar{C} \subseteq \mathbb{P}^2$ is a rational quartic with three ordinary cusps p_1, p_2, p_3 . It has a parameterization $\vartheta: \mathbb{P}^1 \rightarrow \mathbb{P}^2$ given by

$$(4.2) \quad [u : v] \mapsto [u^2 v^2 : v^2 (u - v)^2 : u^2 (u - v)^2],$$

in which case $p_1 = [1 : 0 : 0]$, $p_2 = [0 : 1 : 0]$ and $p_3 = [0 : 0 : 1]$.

Proof. Let $\bar{C} \subseteq \mathbb{P}^2$ be a quartic with three ordinary cusps p_1, p_2, p_3 . Let $\sigma: \mathbb{P}^2 \dashrightarrow \mathbb{P}^2$ be the standard quadratic transformation centered at p_1, p_2, p_3 . Then $\sigma_* \bar{C}$ is a conic tangent to the exceptional lines of σ^{-1} . Conversely, if m is a conic and ℓ_1, ℓ_2, ℓ_3 are distinct lines tangent to m then the standard quadratic transformation centered at $\ell_j \cap \ell_k$ for $j \neq k$ maps m onto a quartic with ordinary cusps at the points

which are images of ℓ_j . Up to an automorphism of \mathbb{P}^2 this transformation is inverse to σ . We obtain a one-to-one correspondence between the classes of projective equivalence of pairs $(\bar{C}, (p_1, p_2, p_3))$ and $(m, (\ell_1, \ell_2, \ell_3))$. The latter is unique. Taking

$$m = \{[(u-v)^2 : u^2 : v^2] : [u : v] \in \mathbb{P}^1\} \quad \text{and} \quad \ell_1 = \{x = 0\}, \ell_2 = \{y = 0\}, \ell_3 = \{z = 0\}$$

we get \bar{C} given by (4.2). \square

Proposition 4.6. Up to a projective equivalence there exists a unique rational cuspidal curve (quintic) of type \mathcal{Q}_3 .

Proof. We describe a one-to-one correspondence between classes of projective equivalence of pairs (\bar{E}, q_1) and $(\bar{C}, (p_1, r_1))$, where $\bar{E} \subseteq \mathbb{P}^2$ is of type \mathcal{Q}_3 , $q_1 \in \text{Sing } \bar{E}$, $\bar{C} \subseteq \mathbb{P}^2$ is a tricuspidal quartic with cusps p_1, p_2, p_3 and $r_1 \in \bar{C}$ is a point such that

(4.3) for $j \in \{2, 3\}$ the line ℓ_j joining r_1 with p_j meets $\bar{C} \setminus \{r_1, p_j\}$ in a (unique) point r_j such that p_1, r_2, r_3 are collinear (see Figure 20).

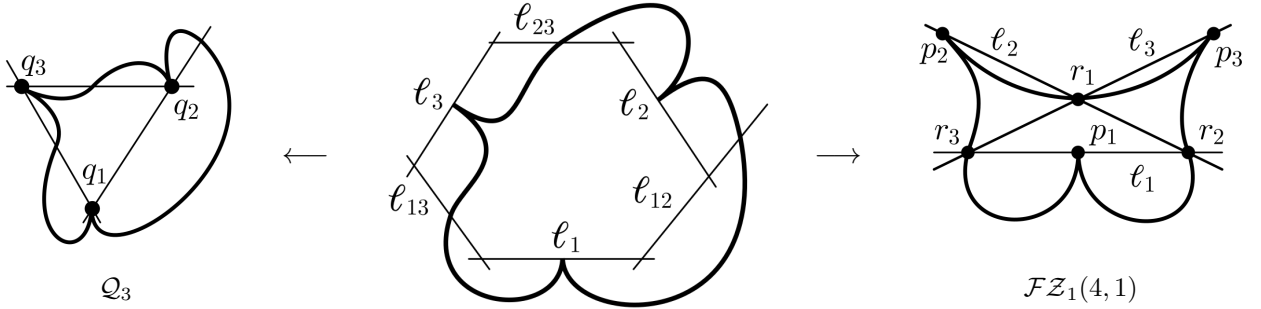

FIGURE 20. A construction of the quintic \mathcal{Q}_3 .

Assume that \bar{E} is of type \mathcal{Q}_3 . Denote by q_1, q_2, q_3 the cusps of \bar{E} and by ℓ_{jk} the line joining q_j with q_k . Let σ be the standard quadratic transformation centered at q_1, q_2, q_3 . Put $\bar{C} := \sigma_* \bar{E}$. Let p_j be the point infinitely near to q_j on \bar{C} and let ℓ_j be the exceptional line of σ^{-1} containing p_j . Put $r_1 := \sigma(\ell_{23})$ and $r_j := \sigma(\ell_{1j})$ for $j \in \{2, 3\}$. Lemma 4.2(b) implies that the lines ℓ_{jk} are not tangent to \bar{E} , so ℓ_{jk} meets $\bar{E} \setminus \{q_j, q_k\}$ once and transversally. Therefore, the points $p_1, p_2, p_3, r_1, r_2, r_3$ lie on \bar{C} and are distinct. The curve \bar{C} is cuspidal, with cusps p_1, p_2, p_3 . The multiplicity sequence of $p_j \in \bar{C}$ is the multiplicity sequence of $q_j \in \bar{E}$ shortened by the initial term, so $p_j \in \bar{C}$ is ordinary. It follows that \bar{C} is a tricuspidal quartic. Because $r_1, p_j, r_j \in \ell_j$ for $j \in \{2, 3\}$ and $p_1, r_2, r_3 \in \ell_1$, the pair $(\bar{C}, (p_1, r_1))$ satisfies (4.3).

Conversely, assume that $(\bar{C}, (p_1, r_1))$ is as in (4.3). Then the standard quadratic transformation centered at r_1, r_2, r_3 maps \bar{C} to a curve of type \mathcal{Q}_3 . Up to an automorphism of \mathbb{P}^2 this transformation is inverse to σ . Therefore, we have a one-to-one correspondence between classes of projective equivalence of pairs (\bar{E}, q_1) and $(\bar{C}, (p_1, r_1))$.

By Lemma 4.5 it remains to show that the class of $(\bar{C}, (p_1, r_1))$ satisfying (4.3) is uniquely determined by the class of (\bar{C}, p_1) . Let (\bar{C}, p_1) be as in (4.2) and let r_1 be a smooth point of \bar{C} , so $r_1 = \vartheta[\alpha : 1]$ for some $\alpha \in \mathbb{C} \setminus \{0, 1\}$. Then for $j \in \{2, 3\}$ the lines ℓ_j joining r_1 with p_j are given by

$$\ell_2 = \{(\alpha - 1)^2 x = z\} \quad \text{and} \quad \ell_3 = \{(\alpha - 1)^2 x = \alpha^2 y\}.$$

Now $\ell_j \cap \bar{C} = \{r_1, p_j, r_j\}$, where $r_2 = \vartheta[2 - \alpha : 1]$ and $r_3 = \vartheta[\alpha : 2\alpha - 1]$. We check that the points p_1, r_2, r_3 are collinear if and only if $(\alpha - 1)^2 = \alpha$. Then $r_1 = [1 : \alpha^{-1} : \alpha]$ and $\alpha = (3 \pm \sqrt{5})/2$. The two possible points r_1 , namely $[2 : 3 + \sqrt{5} : 3 - \sqrt{5}]$ and $[2 : 3 - \sqrt{5} : 3 + \sqrt{5}]$, are mapped to each other by the involution $[x : y : z] \mapsto [x : z : y]$ which fixes (\bar{C}, p_1) . \square

Lemma 4.7. For every curve $C \subseteq \mathbb{P}^2$ other than a line, assigning to an automorphism of (\mathbb{P}^2, C) its pullback to the normalization $\nu: C^\nu \rightarrow C$ defines a monomorphism

$$(4.4) \quad \text{Aut}(\mathbb{P}^2, C) \hookrightarrow \text{Aut}(C^\nu, \nu^{-1}(\text{Sing } C)).$$

Proof. Let $\sigma \in \text{Aut}(\mathbb{P}^2, C)$. By the universal property of the normalization, the morphism $\sigma \circ \nu$ factors as $\sigma \circ \nu = \nu \circ \sigma^\nu$ for some $\sigma^\nu: C^\nu \rightarrow C^\nu$. Since σ^ν is birational and lifts $\sigma|_C$, it is unique and we have $\sigma^\nu \in \text{Aut}(C^\nu, \nu^{-1}(\text{Sing } C))$. It follows from the uniqueness that the assignment $\sigma \mapsto \sigma^\nu$ is a homomorphism. If $\sigma^\nu = \text{id}_{C^\nu}$ then $\sigma|_C = \text{id}$, so $\sigma = \text{id}$, because C spans \mathbb{P}^2 . \square

Remark 4.8 (Properties of \mathcal{Q}_3). Let $\alpha = (3 - \sqrt{5})/2$. We argue that \mathcal{Q}_3 has a parameterization

$$(4.5) \quad [u : v] \mapsto [u^2 v^2 (u - \alpha v) : v^2 (u - v)^2 ((1 - \alpha)u + v) : u^2 (u - v)^2 ((\alpha - 1)u + v)],$$

and that

$$(4.6) \quad \text{Aut}(\mathbb{P}^2, \mathcal{Q}_3) \cong \mathbb{Z}_3.$$

The parameterization, call it $\nu: \mathbb{P}^1 \rightarrow \bar{E}$, follows from the construction in the proof of Proposition 4.6, the three cusps are $[1 : 0 : 0]$, $[0 : 1 : 0]$ and $[0 : 0 : 1]$.

To compute the automorphism group note first that the automorphism $\varepsilon([x : y : z]) = [\alpha y : z : (\alpha - 1)x]$ fixes \bar{E} and cyclically permutes the cusps $q_1 = \nu([1 : 1])$, $q_2 = \nu([0 : 1])$ and $q_3 = \nu([1 : 0])$, hence $\mathbb{Z}_3 \cong \langle \varepsilon \rangle \subseteq \text{Aut}(\mathbb{P}^2, \bar{E})$. Suppose that $\sigma \in \text{Aut}(\mathbb{P}^2, \bar{E}, q_1)$ and $\sigma \neq \text{id}$. Let σ^ν be as in Lemma 4.7. We have $\sigma^\nu([u : v]) = [v : u]$, so $\sigma([x : y : z]) = [x : z : y]$. But this automorphism does not fix \bar{E} , as for instance, the inverse images of the unique points of intersection of $\bar{E} \setminus \{q_1, q_2\}$ with the lines through q_1 and q_j , $j \in \{2, 3\}$, namely $[1 - \alpha : 1]$ and $[\alpha - 1 : 1]$, are not mapped to each other; a contradiction.

Proposition 4.9. Up to a projective equivalence there exists a unique rational cuspidal curve (quintic) of type \mathcal{Q}_4 .

Proof. We describe a one-to-one correspondence between classes of projective equivalence of pairs (\bar{E}, q_2) and $(\bar{C}, (p_1, s_1))$, where $\bar{E} \subseteq \mathbb{P}^2$ is of type \mathcal{Q}_4 , $q_2 \in \bar{E}$ is an ordinary cusp, $\bar{C} \subseteq \mathbb{P}^2$ is a tricuspidal quartic with cusps p_1, p_2, p_3 and $s_1 \in \bar{C}$ is a point such that

$$(4.7) \quad \text{the line tangent to } \bar{C} \text{ at } s_1 \text{ is tangent to } \bar{C} \setminus \{s_1\},$$

see Figure 21, that is, this line is *bitangent* to \bar{C} . Because $\deg \bar{C} = 4$, it meets \bar{C} in exactly two smooth points, with multiplicity 2.

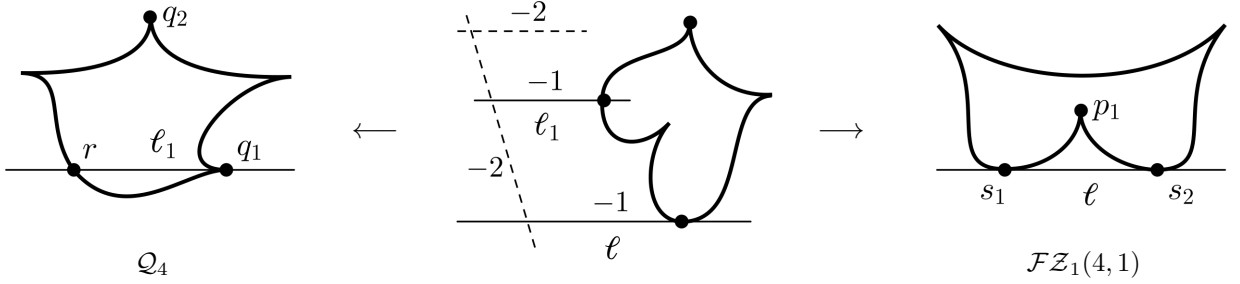

FIGURE 21. A construction of the quintic \mathcal{Q}_4 .

Assume that \bar{E} is of type \mathcal{Q}_4 . Recall that by Lemma 4.2(b) the line ℓ_1 tangent to the cusp $q_1 \in \bar{E}$ with multiplicity sequence $(2, 2, 2)$ satisfies $(\ell_1 \cdot \bar{E})_{q_1} = 4$ and meets $\bar{E} \setminus \{q_1\}$ in a unique point, say r . Blow up three times at q_1 and its infinitely near points on the proper transform of \bar{E} . The exceptional divisor is a chain $V_1 + V_2 + L = [2, 2, 1]$, meeting the proper transforms of ℓ_1 and \bar{E} in V_2 and L , respectively. Contract the proper transform of ℓ_1 , which is a (-1) -curve, and the image of $V_1 + V_2$. Note that this contraction does not touch the proper transform of the germ of \bar{E} at q_1 , which is smooth and meets the image of L with multiplicity 2. Denote the resulting map by $\sigma: \mathbb{P}^2 \dashrightarrow \mathbb{P}^2$ (it is a quadratic transformation with one proper base point, see [AC02, Proposition 8.5.2]). Put $\bar{C} := \sigma_* \bar{E}$, $p_j := \sigma(q_{j+1})$ for $j \in \{1, 2, 3\}$ and $s_1 := \sigma(\ell_1)$. Let ℓ be the image of L and let $s_2 \in \ell$ be the image of the point infinitely near to q_1 , see Figure 21. Then ℓ is a line, $s_1, s_2 \in \bar{C}$ are smooth and $(\bar{C} \cdot \ell)_{s_k} = 2$ for $k \in \{1, 2\}$. Since σ restricts to an isomorphism $\mathbb{P}^2 \setminus \ell_1 \rightarrow \mathbb{P}^2 \setminus \ell$, the curve \bar{C} is a tricuspidal quartic with cusps p_1, p_2, p_3 . Hence, $(\bar{C}, (p_1, s_1))$ satisfies (4.7).

Conversely, let $(\bar{C}, (p_1, s_1))$ be as in (4.7). The line ℓ tangent to \bar{C} at s_1 is bitangent to \bar{C} . Let $\sigma': \mathbb{P}^2 \dashrightarrow \mathbb{P}^2$ be a composition of three blowups at s_1 and its infinitely near points on the proper transforms of \bar{C} , followed by the contraction of the proper transform of ℓ and the images of the first and second exceptional curve. Then σ' maps \bar{C} to a curve of type \mathcal{Q}_4 . Up to an automorphism of \mathbb{P}^2 the map σ' is inverse to σ . Therefore, we have a one-to-one correspondence between classes of projective equivalence of pairs (\bar{E}, q_2) and $(\bar{C}, (p_1, s_1))$.

By Lemma 4.5 it remains to show that the class of $(\bar{C}, (p_1, s_1))$ satisfying (4.7) is uniquely determined by the class of (\bar{C}, p_1) . Let (\bar{C}, p_1) be as in (4.2). Suppose that \bar{C} has two bitangent lines ℓ, ℓ' . Then the four points of tangency are distinct, so the projection from $\ell \cap \ell'$ restricts to a morphism $\bar{C} \rightarrow \mathbb{P}^1$ of

degree 4 ramified at the four points of $(\ell \cup \ell') \cap \bar{C}$ and at three cusps of \bar{C} . This contradicts the Hurwitz formula. Thus \bar{C} has at most one bitangent line, say ℓ . For \bar{C} as in (4.2) this is the line $\ell = \{x+y+z=0\}$, meeting \bar{C} with multiplicity 2 at

$$s_1 = \vartheta[-\zeta : 1] = [1 : \zeta^2 : \zeta] \quad \text{and} \quad s_2 = \vartheta[-\zeta^2 : 1] = [1 : \zeta : \zeta^2],$$

where $\zeta = \exp(2\pi i/3)$. Therefore, the pairs $(\bar{C}, (p_1, s_k))$ for $k \in \{1, 2\}$ satisfy (4.7). The result follows, because the points s_1, s_2 are mapped to each other by the involution $[x : y : z] \mapsto [x : z : y]$ which fixes (\bar{C}, p_1) . \square

Remark 4.10 (Properties of \mathcal{Q}_4). We argue that \mathcal{Q}_4 has a parameterization

$$(4.8) \quad [u : v] \mapsto [uv^4 : v^2(u^3 - v^3) : u^2(u^3 + 2v^3)],$$

and that

$$(4.9) \quad \text{Aut}(\mathbb{P}^2, \mathcal{Q}_4) \cong \mathbb{Z}_3.$$

The parameterization, call it $\nu: \mathbb{P}^1 \rightarrow \bar{E}$, follows from the construction from the proof of Proposition 4.9, it is also given in [Nam84, 2.3.10.6]. The curve \bar{E} has a cusp with multiplicity sequence $(2, 2, 2)$ at $q_1 = \nu([1 : 0])$ and ordinary cusps $q_{2+k} = \nu([-\zeta^k : \sqrt[3]{2}])$, where $\zeta = \exp(2\pi i/3)$ and $k \in \{0, 1, 2\}$.

To compute the automorphism group we use Lemma 4.7. Note that $\varepsilon([x : y : z]) = [\zeta x : y : \zeta^2 z]$ fixes \bar{E} and cyclically permutes the ordinary cusps, hence $\mathbb{Z}_3 \cong \langle \varepsilon \rangle \subseteq \text{Aut}(\mathbb{P}^2, \bar{E})$. If $\sigma \in \text{Aut}(\mathbb{P}^2, \bar{E}, q_2)$ then σ^ν as in Lemma 4.7 fixes $[-1 : \sqrt[3]{2}]$, $[1 : 0]$ and $\{[-\zeta : \sqrt[3]{2}], [-\zeta^2 : \sqrt[3]{2}]\}$, which is possible only if $\sigma^\nu = \text{id}_{\mathbb{P}^1}$. Thus (4.9) holds.

Remark 4.11 (Other proofs of existence for types $\mathcal{Q}_3, \mathcal{Q}_4$).

- (a) Let $\iota_3, \iota_4: \mathbb{C}^* \rightarrow \mathbb{C}^2$ be the injective morphisms given, respectively, by (v) and (w) in [BZ10]. Via an automorphism of \mathbb{C}^2 they are equivalent to $\bar{E} \setminus \ell_1 \hookrightarrow \mathbb{P}^2 \setminus \ell_1$, where \bar{E} is of type \mathcal{Q}_3 or \mathcal{Q}_4 , respectively, and ℓ_1 is the line tangent to $q_1 \in \bar{E}$. Indeed, let $j_3, j_4: \mathbb{C}^2 \hookrightarrow \mathbb{P}^2$ be embeddings given by

$$j_3(x, y) = [x : 4(1 + \sqrt{5})y - x^2 : 1], \quad j_4(x, y) = [x : 8y - x^2 : 1].$$

Then the closures of the images of $j_3 \circ \iota_3$ and $j_4 \circ \iota_4$ are of type \mathcal{Q}_3 and \mathcal{Q}_4 , respectively.

- (b) A construction of curves of types \mathcal{Q}_3 and \mathcal{Q}_4 , similar to ours, that is, using quadratic transformations applied to simple planar configurations, is given in [Moe08, Section 6.3].

4C. Existence and uniqueness for types $\mathcal{FZ}_2, \mathcal{FE}$ and \mathcal{H} .

The existence and uniqueness of the curves $\mathcal{FZ}_2(\gamma)$, $\gamma \geq 4$ is proved in [FZ00] by showing that some quadratic transformation maps a curve of type $\mathcal{FZ}_2(\gamma)$ to a curve of type $\mathcal{FZ}_2(\gamma + 1)$. The existence and uniqueness of Fenske curves \mathcal{FE} is shown in [Fen99] by a similar method.

The type $\mathcal{H}(\gamma)$ is realized by the closure of the embedding $\mathbf{sq}-(k)$, $k = \gamma - 1$ from [CNKR09, 6.9.3], given by the formula in Theorem 8.2(iii) loc. cit. Indeed, that closure has two points at infinity, which are cusps described by Hamburger–Noether pairs $(\binom{4}{4\gamma-2})\binom{2}{3}$ and $(\binom{3\gamma-3}{3\gamma})\binom{3}{1}$, so their multiplicity sequences are $((4)_{\gamma-1}, 2, 2, 2)$ and $(3\gamma - 3, (3)_{\gamma-1})$, respectively (cf. [PP17, Lemma 2.11]). Hence it is of type $\mathcal{H}(\gamma)$. This proves that curves of type $\mathcal{H}(\gamma)$ do exist.

Assume that \bar{E} is of type $\mathcal{H}(\gamma)$, $\gamma \geq 3$. By Lemma 4.2(a) the line ℓ_{12} joining the cusps of \bar{E} does not meet the smooth part of \bar{E} , so $\bar{E} \setminus \ell_{12} \subseteq \mathbb{P}^2 \setminus \ell_{12}$ is a proper embedding $\mathbb{C}^* \hookrightarrow \mathbb{C}^2$. By Lemma 4.2(b) the line ℓ_1 tangent to $q_1 \in \bar{E}$ meets $\bar{E} \setminus \ell_{12}$ once and transversally, so it is a good asymptote for $\bar{E} \setminus \ell_{12} \subseteq \mathbb{P}^2 \setminus \ell_{12}$. The classification [CNKR09, Theorem 8.2] of proper embeddings $\mathbb{C}^* \hookrightarrow \mathbb{C}^2$ which admit a good asymptote implies that the embedding $\bar{E} \setminus \ell_{12} \subseteq \mathbb{P}^2 \setminus \ell_{12}$ is unique up to an automorphism of $\mathbb{P}^2 \setminus \ell_{12} \cong \mathbb{C}^2$. To infer the projective uniqueness of $\bar{E} \subseteq \mathbb{P}^2$, one needs to show that any automorphism of $(\mathbb{P}^2 \setminus \ell_{12}, \bar{E} \setminus \ell_{12})$ extends to an automorphism of (\mathbb{P}^2, \bar{E}) . This is done in [PP17, Lemma 4.6] for closures of some other embeddings, but the proof for $\mathcal{H}(\gamma)$ is exactly the same. It relies of the fact that the surface $\mathbb{P}^2 \setminus (\bar{E} \cup \ell_{12})$, being of log general type, admits a unique minimal log smooth completion, which in turn is uniquely determined by the singularities of $\bar{E} + \ell_{12}$. We leave the details to the reader.

Remark 4.12 (Other proofs of existence for types $\mathcal{FZ}_2, \mathcal{FE}$, and \mathcal{H}).

- (a) A curve \bar{E} of type $\mathcal{FZ}_2(k+2)$ for $k \geq 2$ can be also obtained as the closure of the image of a singular embedding $\mathbb{C}^* \rightarrow \mathbb{C}^2$ given by [BZ10, (g)] via the standard embedding $\mathbb{C}^2 \ni (x, y) \mapsto [x : y : 1] \in \mathbb{P}^2$. Then the line $\{z = 0\}$ at infinity is the line ℓ_{12} joining $q_1, q_2 \in \bar{E}$. Another way to get this curve is to note that the line ℓ_1 tangent to $q_1 \in \bar{E}$ meets \bar{E} in two points, so $\bar{E} \setminus \ell_1 \subseteq \mathbb{P}^2 \setminus \ell_1$ is a singular

embedding $\mathbb{C}^* \rightarrow \mathbb{C}^2$. One can check that it is given by [BZ10, (k)] via the embedding $(x, y) \mapsto [x : y - \sum_{l=1}^k a_l x^{k-l+2} : 1]$, where $a_1 = 1$ and $a_{l+1} = (-1)^l \left(\binom{3l-2}{l} + 4 \binom{3l-2}{l-1} \right) - \sum_{r=1}^l (-1)^r \binom{3r}{r} a_{l+1-r}$ for $l \geq 1$.

- (b) A curve \bar{E} of type $\mathcal{FE}(k+3)$ for $k \geq 2$ can be obtained as the closure of the image of a singular embedding $\mathbb{C}^* \rightarrow \mathbb{C}^2$ given by [BZ10, (h)] via the standard embedding $\mathbb{C}^2 \ni (x, y) \mapsto [x : y : 1] \in \mathbb{P}^2$. As in (a), the line $\{z=0\}$ at infinity is the line ℓ_{12} joining $q_1, q_2 \in \bar{E}$. Choosing for the line at infinity the one tangent to $q_1 \in \bar{E}$, we get another singular embedding $\mathbb{C}^* \rightarrow \mathbb{C}^2$, and one can check that it is given by [BZ10, (p)] via the embedding $(x, y) \mapsto [x : y - \sum_{l=1}^k a_l x^{k-l+2} : 1]$, where $a_1 = 1$ and $a_{l+1} = (-1)^l \left(\binom{4l-2}{l} + 3 \binom{4l-2}{l-1} \right) - \sum_{r=1}^l (-1)^r \binom{4r}{r} a_{l+1-r}$ for $l \geq 1$.
- (c) Similarly, a curve \bar{E} of type $\mathcal{H}(k+1)$ for $k \geq 2$ can be obtained as the closure of the image of an embedding $\mathbb{C}^* \rightarrow \mathbb{C}^2$ given by [BZ10, (i)] via the standard embedding $\mathbb{C}^2 \ni (x, y) \mapsto [x : y : 1] \in \mathbb{P}^2$. Then the line at infinity joins the two cusps of \bar{E} . Again, one can check that $\bar{E} \setminus \ell_1 \subseteq \bar{E} \setminus \ell_1$, where ℓ_1 is the line tangent to $q_1 \in \bar{E}$, is a singular embedding $\mathbb{C}^* \rightarrow \mathbb{C}^2$ given by [BZ10, (o)] with parameters (m, n) equal to $(1, k)$, via the embedding $\mathbb{C}^2 \ni (x, y) \mapsto [y : x - \sum_{l=1}^k a_l y^{k-l+2} : 1] \in \mathbb{P}^2$, where $a_1 = 1$ and $a_{l+1} = (-1)^l \left(\binom{4l-2}{l} - \binom{4l-2}{l-1} \right) - \sum_{r=1}^l (-1)^r \binom{4r}{r} a_{l+1-r}$ for $l \geq 1$.
- (d) An inductive construction of the series \mathcal{H} by quadratic transformations was given recently by J. Bodnár, see [Bod16b, Theorem 3.1(e)].
- (e) Theorem 1.2 and [PP17, Theorem 1.3] yield the following characterization. A rational cuspidal curve $\bar{E} \subseteq \mathbb{P}^2$ with complement of log general type is of type $\mathcal{H}(\gamma)$ for some $\gamma \geq 3$ if and only if the surface $\mathbb{P}^2 \setminus \bar{E}$ admits no \mathbb{C}^{**} -fibration and \bar{E} is a closure of the image of a smooth proper embedding $\mathbb{C}^* \hookrightarrow \mathbb{C}^2$ with a good asymptote. Note that [CNKR09, Theorem 8.2(iii)] allows $\gamma = k - 1 = 2$ which we do not, because in this case \bar{E} is of type $\mathcal{A}(2, 2, 1)$ from [PP17, Theorem 1.3], so $\mathbb{P}^2 \setminus \bar{E}$ has a \mathbb{C}^{**} -fibration.

4D. Existence and uniqueness for types \mathcal{I} and \mathcal{J} .

To prove the existence and uniqueness of curves of types \mathcal{I} and \mathcal{J} we first show the uniqueness of minimal models $(X_{\min}, \frac{1}{2}D_{\min})$ of the corresponding log surfaces $(X_0, \frac{1}{2}D_0)$ which appeared in Section 3. Recall that $\mathbb{F}_2 := \mathbb{P}(\mathcal{O}_{\mathbb{P}^1}(2) \oplus \mathcal{O}_{\mathbb{P}^1})$ and denote by $\tilde{\Delta}^-$ the negative section of \mathbb{F}_2 .

Lemma 4.13 (Recovering (Z, D_Z) , cf. (3.1)). The following configurations exist and are unique up to an isomorphism of pairs:

- (a) $(\mathbb{P}^2, \tilde{C}_1 + \tilde{C}_2 + \tilde{E}_0)$, where \tilde{C}_1, \tilde{C}_2 are conics meeting with multiplicities 3, 1 and \tilde{E}_0 is a line tangent to \tilde{C}_1 and \tilde{C}_2 off $\tilde{C}_1 \cap \tilde{C}_2$ (see Figure 18).
- (b) $(\mathbb{F}_2, \tilde{\Delta}^- + \tilde{C}_1 + \tilde{C}_2 + \tilde{E}_0)$, where $\tilde{C}_1, \tilde{C}_2, \tilde{E}_0$ are 1-sections such that $\tilde{C}_1 \cdot \tilde{\Delta}^- = 1$, $\tilde{C}_2 \cdot \tilde{\Delta}^- = \tilde{E}_0 \cdot \tilde{\Delta}^- = 0$, \tilde{C}_1 meets \tilde{C}_2 in two points (with multiplicities 1, 2) and \tilde{E}_0 meets each \tilde{C}_j , $j \in \{1, 2\}$ in a unique point off $\tilde{C}_1 \cap \tilde{C}_2$ (with multiplicity $4 - j$), (see Figure 13).

Proof. (a) Since up to a projective equivalence there exists a unique conic with an ordered triple of distinct points on it, the triple $(\tilde{C}_1 + \tilde{E}_0, p, p')$, where \tilde{E}_0 is a line tangent to a conic \tilde{C}_1 and p, p' are distinct points of $\tilde{C}_1 \setminus \tilde{E}_0$, is unique up to a projective equivalence, say, $\tilde{C}_1 = \{x^2 = yz\}$, $\tilde{E}_0 = \{z = 0\}$, $p = [1 : 1 : 1]$ and $p' = [0 : 0 : 1]$. The pencil of conics tangent to \tilde{C}_1 with multiplicity 3 at p' and passing through p is given by

$$\{\lambda(x^2 - yz) = \mu y(y - x)\}_{[\lambda:\mu] \in \mathbb{P}^1}.$$

It contains a unique smooth member tangent to \tilde{E}_0 , namely $\tilde{C}_2 = \{x^2 - yz = 4y(y - x)\}$.

(b) Let $\tilde{C}_1 + \tilde{C}_2 + \tilde{E}_0$ be as in (a). Denote by p the point where \tilde{C}_1 and \tilde{C}_2 meet transversally and by ℓ the line tangent to \tilde{C}_2 at p . Let $\vartheta: \mathbb{P}^2 \dashrightarrow \mathbb{F}_2$ be a blow up at p and its infinitely near point on the proper transform of ℓ followed by the contraction of the latter. Then $\vartheta_*(\tilde{C}_1 + \tilde{C}_2 + \tilde{E}_0)$ is as in (b), where $\vartheta_*\tilde{C}_1$, $\vartheta_*\tilde{C}_2$ and $\vartheta_*\tilde{E}_0$ correspond to \tilde{C}_1 , \tilde{E}_0 and \tilde{C}_2 , respectively. Conversely, let $\tilde{C}_1 + \tilde{C}_2 + \tilde{E}_0$ be as in (b), let p' be the point where \tilde{C}_1 and \tilde{C}_2 meet transversally and let F be the fiber through p' . Let $\eta: \mathbb{F}_2 \dashrightarrow \mathbb{P}^2$ be a blowup at p' followed by the contraction of the proper transform of $F + \tilde{\Delta}^-$. Then $\eta_*(\tilde{C}_1 + \tilde{C}_2 + \tilde{E}_0)$ is as in (a), where $\eta_*\tilde{C}_1$, $\eta_*\tilde{C}_2$ and $\eta_*\tilde{E}_0$ correspond to \tilde{C}_1 , \tilde{E}_0 and \tilde{C}_2 , respectively. Clearly, η and ϑ are inverse to each other. Hence, (b) follows from (a) and from the universal property of blowing up. \square

Proposition 4.14. Planar rational cuspidal curves of types \mathcal{I} and $\mathcal{J}(k)$, $k \geq 2$ exist and are unique up to a projective equivalence.

Proof. For a construction of a curve of type \mathcal{I} let (Z, D_Z) be as in Lemma 4.13(b), see Figure 13. Write $\tilde{C}_1 \cap \tilde{C}_2 = \{p, p'\}$ where $(\tilde{C}_1 \cdot \tilde{C}_2)_p = 2$, $(\tilde{C}_1 \cdot \tilde{C}_2)_{p'} = 1$. Let $\alpha_2^+ : X_2 \rightarrow Z$ be the blowup at p and its infinitely near point on the proper transform of D_Z . Put $\hat{C}_j := (\alpha_2^+)_*^{-1} \tilde{C}_j$, $j \in \{1, 2\}$ and let $\Upsilon_2 \subseteq X_2$ be the last exceptional curve of α_2^+ , so $\Upsilon_2^2 = -1$ and $\Upsilon_2 + \hat{C}_1 + \hat{C}_2$ is circular. Now let $\psi : X_0 \rightarrow X_2$ be the composition of blowups over $\hat{C}_1 \cap \hat{C}_2$, $\hat{C}_1 \cap \Upsilon_2$ whose centers are double points of the subsequent preimages of $\Upsilon_2 + \hat{C}_1 + \hat{C}_2$ (so $\psi^*(\Upsilon_2 + \hat{C}_1 + \hat{C}_2)_{\text{red}}$ is circular, too), such that $\psi^{-1}(\hat{C}_1 \cap \hat{C}_2)_{\text{red}}$ and $\psi^{-1}(\hat{C}_1 \cap \Upsilon_2)_{\text{red}}$ are chains $[1, 2]$ and $[3, 2, 1, 3]$, respectively, meeting $\psi_*^{-1} \hat{C}_1$ in their first tips.

For a construction of a curve of type $\mathcal{J}(k)$, $k \geq 2$ let (Z, D_Z) be as in Lemma 4.13(a), see Figure 18. Write $\tilde{C}_1 \cap \tilde{C}_2 = \{p, p'\}$ where $(\tilde{C}_1 \cdot \tilde{C}_2)_p = 1$, $(\tilde{C}_1 \cdot \tilde{C}_2)_{p'} = 3$. Blow up three times at p' and its infinitely near points on the proper transforms of D_Z and denote this morphism by $\alpha_2^+ : X_2 \rightarrow Z$. As before, put $\hat{C}_j := (\alpha_2^+)_*^{-1} \tilde{C}_j$, $j \in \{1, 2\}$ and denote by $\Upsilon_2 \subseteq X_2$ the last exceptional curve of α_2^+ . Now let $\psi : X_0 \rightarrow X_2$ be the composition of blowups over $\hat{C}_1 \cap \hat{C}_2$, $\Upsilon_2 \cap \hat{C}_2$ and at double points of the subsequent preimages of $\Upsilon_2 + \hat{C}_1 + \hat{C}_2$, such that $\psi^{-1}(\hat{C}_1 \cap \hat{C}_2)_{\text{red}}$ and $\psi^{-1}(\Upsilon_2 \cap \hat{C}_2)_{\text{red}}$ are chains $[(2)_{k-1}, 1, k+1]$ and $[1, (2)_{k-1}]$, respectively, meeting $\psi_*^{-1} \hat{C}_2$ in their last tips.

For both types put $\psi^+ = \alpha_2^+ \circ \psi$, $E_0 = (\psi^+)_*^{-1} \tilde{E}_0$ and write $((\psi^+)^* D_Z)_{\text{red}} = D_0 + A + A'$, where A and A' are the (-1) -curves in the preimages of p and p' , respectively. Computing the changes of self-intersection numbers of the components of D_Z we infer that connected components of $D_0 - E_0$ contract to smooth points. The resulting surface has Picard rank

$$\rho(X_0) - \#(D_0 - E_0) = \rho(X_0) - \#((\psi^+)^* D_Z)_{\text{red}} + 3 = \rho(Z) - \#D_Z + 3 = 1,$$

so it is \mathbb{P}^2 . Looking at the weighted graph of D_0 we see that the image of E_0 is a cuspidal curve of type \mathcal{I} and $\mathcal{J}(k)$, respectively. Therefore, such curves do exist.

Let $\bar{E} \subseteq \mathbb{P}^2$ be of type \mathcal{I} or $\mathcal{J}(k)$ for some $k \geq 2$. We prove the projective uniqueness of \bar{E} in each case. As before, let $\pi_0 : (X_0, D_0) \rightarrow (\mathbb{P}^2, \bar{E})$ be the minimal weak resolution. We use Notation 2.6 for the components of D_0 . By the results of Section 4A the surface $\mathbb{P}^2 \setminus \bar{E}$ satisfies (2.9). By Lemma 3.2(h) the pair $(X_0, \frac{1}{2}D_0)$ is not almost minimal. In Section 3 we have shown that for such curves we can run the almost MMP for $(X_0, \frac{1}{2}D_0)$ as in Propositions 3.10 and 3.16. In particular, $n = 2$ and the proper transforms $A, A' \subseteq X_0$ of the contracted almost log exceptional curves are (-1) -curves such that $A \cdot D_0 = A' \cdot D_0 = 2$ and

- (a) if \bar{E} is of type \mathcal{I} then A meets $\text{tip}^+(T_1)$ and $\text{tip}^+(T_2)$, and A' meets C_1 and the (-2) -tip of Q_2 meeting C_2 , see Figure 13.
- (b) if \bar{E} is of type \mathcal{J} then A meets $\text{tip}^+(T'_1)$ and $\text{tip}^+(T_2)$, and A' meets $\text{tip}^-(T_1)$ and $\text{tip}^+(T'_2)$, see Figure 18.

The above properties specify the intersection numbers of A and A' with all the components of D_0 . Since the Néron-Severi group $\text{NS}_{\mathbb{Q}}(X_0)$ is generated freely by the classes of components of D_0 , the numerical classes of A and A' are uniquely determined. Since $A^2 < 0$ and $(A')^2 < 0$, the curves A, A' are unique.

Now we prove that a morphism $\psi^+ = \alpha_2^+ \circ \psi : (X_0, D_0) \rightarrow (Z, D_Z)$ as in Section 3, see Figures 13 and 18, is uniquely determined by $\bar{E} \subseteq \mathbb{P}^2$. We check directly that in our cases $\text{Exc } \psi_A$ and $\text{Exc } \psi_{A'}$ are disjoint (see Lemmas 4.1 and 2.20(b)). Let $\psi : (X_0, D_0) \rightarrow (X_2, D_2)$ be the contraction of $\text{Exc } \psi_A + \text{Exc } \psi_{A'}$. The morphism ψ is uniquely determined by $(X_0, D_0 + A + A')$, see Definition 2.12, hence by (X_0, D_0) , and in consequence by $\bar{E} \subseteq \mathbb{P}^2$. Let $\Upsilon_2 + \Delta_2^+ \subseteq X_2$ be as in Notation 2.13 (see Figure 4). Let $\alpha_2^+ : (X_2, D_2) \rightarrow (Z, D_Z)$ be the contraction of $\Upsilon_2 + \Delta_2^+$ (in our cases Υ_2 is a unique (-1) -curve in D_2 and Δ_2^+ is a unique (-2) -twig of D_2 meeting Υ_2). We check that for \bar{E} of type \mathcal{I} or $\mathcal{J}(k)$ the pair (Z, D_Z) is as in Lemma 4.13(b) or (a), respectively (see Propositions 3.10 and 3.16). Therefore, we have shown that a curve $\bar{E} \subseteq \mathbb{P}^2$ of type \mathcal{I} or $\mathcal{J}(k)$ uniquely determines, via $\psi^+ = \alpha_2^+ \circ \psi$, a pair (Z, D_Z) as in Lemma 4.13(b) or (a), respectively, together with a pair of points $p, p' \in \tilde{C}_1 \cap \tilde{C}_2$ which are centers of ψ^+ .

Conversely, given a pair (Z, D_Z) as in Lemma 4.13(b) or (a), there is a unique sequence of blowups over $\tilde{C}_1 \cap \tilde{C}_2 = \{p, p'\}$ such that the weighted graph of the total transform of D_Z is the same as that of $D_0 + A + A'$, where D_0 is as required for the minimal weak resolution of $\bar{E} \subseteq \mathbb{P}^2$ of type \mathcal{I} or $\mathcal{J}(k)$, respectively, and $A + A'$ is as in (a) and (b). Indeed, since the preimage of each of these points is a chain which has a unique (-1) -curve and meets the proper transform of D_Z in tips, we see by induction that the center of each blowup is uniquely determined as the common point of a specific pair of components of the preimage of D_Z . Therefore, we have a one-to-one correspondence between the isomorphism classes of pairs (Z, D_Z) and (X_0, D_0) , and consequently, of pairs (\mathbb{P}^2, \bar{E}) of respective type. Thus the projective uniqueness of \bar{E} follows from the uniqueness of (Z, D_Z) proved in Lemma 4.13. \square

Remark 4.15 (An alternative way to obtain A and A'). In the above proof of the projective uniqueness of $\bar{E} \subseteq \mathbb{P}^2$ the key role is played by the curves $A, A' \subseteq X_0$ used to reconstruct the process ψ of almost minimalization. We have obtained them using the description of ψ from Section 3. Below we sketch how to find them directly using the geometry of $\bar{E} \subseteq \mathbb{P}^2$. As we will see, the curve $\pi_0(A)$ for type \mathcal{I} is a line and $\pi_0(A), \pi_0(A')$ for type \mathcal{J} are conics. But for type \mathcal{I} the curve $\pi_0(A')$ is a specific quartic, more difficult to see directly on \mathbb{P}^2 .

(a) (Type \mathcal{I} , see Figure 13). The curve A is the proper transform of the line ℓ_{12} from Lemma 4.2(a). In order to construct A' let ϑ be the contraction of A and of all new (-1) -curves in the subsequent images of D_0 followed by the blowup at the image of $C_2 \cap E_0$ and its infinitely near point on the proper transform of E_0 . Let V and C_2^\dagger be, respectively, the first and the second exceptional curve over $C_2 \cap E_0$. Put $\hat{D}_0 := \vartheta_* D_0 + V + C_2^\dagger$. We have $(\vartheta_* E_0)^2 = E^2 + \tau_1 = 0$, so $|\vartheta_* E_0|$ induces a \mathbb{P}^1 -fibration, see Figure 22. We use Notation 2.3 for this \mathbb{P}^1 -fibration. The horizontal part of \hat{D}_0 consists of a 3-section $\vartheta_* C_1$ and a

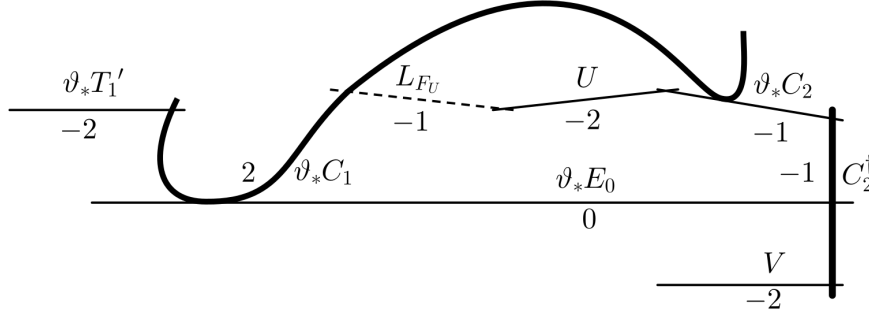

FIGURE 22. The \mathbb{P}^1 -fibration from Remark 4.15(a).

1-section C_2^\dagger . The divisor $(\hat{D}_0 - \vartheta_* E_0)_{\text{vert}}$ has three connected components, namely $V = [2]$, $\vartheta_* T_1' = [2]$ and a chain $[2, 1]$. The first component, say U , of the latter chain is a (-2) -tip of \hat{D}_0 . The second one equals $\vartheta_* C_2$ and meets $\vartheta_* C_1$ and C_2^\dagger with multiplicities 2 and 1, respectively. In particular, the multiplicity $\mu(\vartheta_* C_2)$ of $\vartheta_* C_2$ in the fiber equals $\mu(\vartheta_* C_2) \vartheta_* C_2 \cdot C_2^\dagger \leq \vartheta_* E_0 \cdot C_2^\dagger = 1$, so $\mu(\vartheta_* C_2) = 1$. Denote by F_V and F_U the fibers containing V and U , respectively. Lemma 2.4 implies that every fiber $F \neq \vartheta_* E_0$ has a unique component, say L_F , not contained in $(\hat{D}_0)_{\text{vert}}$. We have $\vartheta_* C_2 \not\subseteq F_V$, because V and $\vartheta_* C_2$ meet the same 1-section C_2^\dagger . Since $F_V \neq V + L_{F_V}$, it follows that F_V contains $\vartheta_* T_1'$, so $F_U \wedge (\hat{D}_0)_{\text{vert}}$ is connected. Because $\mu(\vartheta_* C_2) = 1$, $\vartheta_* C_2$ is a tip of F_U , so the contractibility of F_U to a 0-curve implies that $L_{F_U}^2 = -1$ and that L_{F_U} meets $(\hat{D}_0)_{\text{vert}}$ only in U . Moreover,

$$L_{F_U} \cdot C_2^\dagger = 1 - (F_U - L_{F_U}) \cdot C_2^\dagger = 0 \quad \text{and} \quad L_{F_U} \cdot \vartheta_* C_1 = 3 - (F_U - L_{F_U}) \cdot \vartheta_* C_1 = 1,$$

so $A' := \vartheta_*^{-1} L_{F_U}$ satisfies the required conditions.

(b) (Type $\mathcal{J}(k)$, $k \geq 2$, see Figure 18). Consider the decomposition $\pi_0 = \vartheta \circ \eta$, where ϑ is a composition of a blow up at q_2 and three blowups over q_1 and its infinitely near points on the proper transforms of \bar{E} . Let $\ell_1, \ell_{12} \subseteq \mathbb{P}^2$ be as in Lemma 4.2. Put $L_1 = \vartheta_*^{-1} \ell_1$, $L_{12} = \vartheta_*^{-1} \ell_{12}$, denote by V_j the last exceptional curve of ϑ^{-1} over q_j , $j \in \{1, 2\}$ and put $W = \text{Exc } \vartheta - V_1 - V_2$. Looking at the multiplicity sequences of $q_1, q_2 \in \bar{E}$ listed in Table 1, we show that for $j \in \{1, 2\}$ the curve $\vartheta_*^{-1} \bar{E}$ has a cusp $q'_j \in V_j \setminus W$ with multiplicity sequence $(2)_k$. Recall from Lemma 4.2(b) that ℓ_1 meets $\bar{E} \setminus \{q_1\}$ once and transversally. We have $\deg \bar{E} = \mu_1 + \mu_2 + 1$ and $\mu'_2 = 2 > 1$ (see Table 1), so arguing as in the proof of Lemma 4.2 we show that ℓ_{12} meets $\bar{E} \setminus \{q_1, q_2\}$ once and transversally, too. It follows that $L_1 \cdot \vartheta_*^{-1} \bar{E} = L_{12} \cdot \vartheta_*^{-1} \bar{E} = 1$. Since $W \cdot \vartheta_*^{-1} \bar{E} = 0$, the linear system of $L_1 + W + L_{12} = [1, 2, 2, 1]$ induces a \mathbb{P}^1 -fibration such that $\vartheta_*^{-1} \bar{E}$ is a 2-section. Lemma 2.4 implies that $L_1 + W + L_{12}$ is the unique degenerate fiber. In particular, for $j \in \{1, 2\}$ the fiber F_j passing through q'_j is smooth. Now $F_j \cdot W = 0$, $F_j \cdot V_{j'} = 1$ for $j' \in \{1, 2\}$ and F_j meets $\vartheta_*^{-1} \bar{E}$ only in q'_j , with multiplicity 2. It follows that η touches $\eta_*^{-1} F_j$ exactly once. Then $(\eta_*^{-1} F_j)^2 = -1$ and we see that $A := \eta_*^{-1} F_1$, $A' := \eta_*^{-1} F_2$ satisfy the required conditions.

Remark 4.16 (A new proof of existence and uniqueness of curves $\mathcal{FZ}_2, \mathcal{FE}$ and \mathcal{H}). The above procedure can also be applied to construct rational cuspidal curves of types $\mathcal{FZ}_2, \mathcal{FE}$ and \mathcal{H} and to give a geometric proof of their projective uniqueness. We sketch the argument, leaving the details to the reader. First, one shows that the following configurations (Z, D_Z) are unique up to an isomorphism of pairs:

- (a) $(\mathbb{P}^2, \tilde{E}_0 + \tilde{C}_1 + \tilde{C}_2)$, where \tilde{E}_0 is a cuspidal cubic and \tilde{C}_j , $j \in \{1, 2\}$ is a line tangent to \tilde{E}_0 with multiplicity $j + 1$, see Figure 16.
- (b) $(\mathbb{F}_2, \tilde{\Delta}^- + \tilde{C}_1 + \tilde{C}_2 + \tilde{E}_0)$, where \tilde{C}_1 is a fiber of the unique \mathbb{P}^1 -fibration of \mathbb{F}_2 , \tilde{C}_2 is a 1-section and \tilde{E}_0 is a rational cuspidal 2-section such that $\tilde{C}_2 + \tilde{E}_0$ is disjoint from $\tilde{\Delta}^-$, \tilde{E}_0 is tangent to \tilde{C}_1 off \tilde{C}_2 and meets \tilde{C}_2 with multiplicities 3, 1, see Figure 12.
- (c) $(\mathbb{P}^2, \tilde{E}_0 + \tilde{C}_1 + \tilde{C}_2)$, where \tilde{E}_0, \tilde{C}_1 are conics meeting with multiplicities 3, 1 and \tilde{C}_2 is a line tangent to \tilde{E}_0 and \tilde{C}_1 off $\tilde{E}_0 \cap \tilde{C}_1$, see Figure 17 (cf. Lemma 4.13(a)).

For a construction of curves of type \mathcal{FZ}_2 , \mathcal{FE} or \mathcal{H} let (Z, D_Z) be as in (a), (b) or (c), respectively. As in the proof of Proposition 4.14, we see that it is possible to choose a morphism $\psi^+ : (X_0, D_0 + A + A') \rightarrow (Z, D_Z)$, with weighted graphs as in Figures 16, 12 and 17, respectively. Then the connected components of $D_0 - (\psi^+)_*^{-1}\tilde{E}_0$ contract to points on \mathbb{P}^2 and the image of $(\psi^+)_*^{-1}\tilde{E}_0$ is a rational cuspidal curve of the respective type.

To see the projective uniqueness let $\bar{E} \subseteq \mathbb{P}^2$ be of type \mathcal{FZ}_2 , \mathcal{FE} or \mathcal{H} . Then there exist unique (-1) -curves $A, A' \subseteq X_0$ such that $A \cdot D_0 = A' \cdot D_0 = 2$, A meets $\text{tip}^+(T_1)$ and $\text{tip}^+(T_2)$ and A' meets $\text{tip}^+(T'_1)$ and E_0 . Indeed, A and A' can be taken as the proper transforms of the lines ℓ_{12} and ℓ_1 from Lemma 4.2, respectively. Again, since the numerical classes of A, A' are uniquely determined by their intersection numbers with the components of D_0 , we infer from the inequalities $A^2 < 0$, $(A')^2 < 0$ that A, A' are unique. We check that $\psi^+ : (X_0, D_0) \rightarrow (Z, D_Z)$ defines a bijection between the classes of projective equivalence of $\bar{E} \subseteq \mathbb{P}^2$ and the isomorphism classes of pairs (Z, D_Z) . Therefore, in each case $\bar{E} \subseteq \mathbb{P}^2$ is unique up to a projective equivalence.

Remark 4.17 (Other proofs of existence for types \mathcal{I} and \mathcal{J}).

- (a) A curve of type \mathcal{I} can also be obtained as the closure of the embedding $\mathbb{C}^* \hookrightarrow \mathbb{C}^2$ given by [BZ10, (t)] via the standard embedding $\mathbb{C}^2 \ni (x, y) \mapsto [x : y : 1] \in \mathbb{P}^2$. A curve of type $\mathcal{J}(k)$ for $k \geq 2$ can be obtained as a closure of the singular embedding $\mathbb{C}^* \rightarrow \mathbb{C}^2$ given by [BZ10, (n)], with parameters (l, m, n) equal to $(1, k + 1, 1)$. But for this one needs to use a very specific embedding $\mathbb{C}^2 \hookrightarrow \mathbb{P}^2$, given by

$$(x, y) \mapsto [x - y : 4x - (x - y)^2 : 1].$$

- (b) M. Zaidenberg informed us that the existence of curves of type $\mathcal{J}(k)$ was most likely known to Tom Dieck, who listed their multiplicity sequences in his private correspondence with H. Flenner in 1995. An inductive construction of this series by Cremona maps was given recently by J. Bodnár [Bod16b, Theorem 3.1(c)].
- (c) The classification of proper smooth embeddings $\mathbb{C}^* \hookrightarrow \mathbb{C}^2$ will be established in a forthcoming article [KP16]. The most exceptional case is the curve of type \mathcal{I} . Together with [PP17, Theorem 1.3] one gets the following characterization. A rational cuspidal curve $\bar{E} \subseteq \mathbb{P}^2$ with a complement of log general type is of type \mathcal{I} if and only if the surface $\mathbb{P}^2 \setminus \bar{E}$ admits no \mathbb{C}^{**} -fibration and \bar{E} is the closure of the image of a smooth proper embedding $\mathbb{C}^* \hookrightarrow \mathbb{C}^2$ with no good asymptote.

4E. A direct proof of nonexistence of \mathbb{C}^{**} -fibrations.

The proof of nonexistence of \mathbb{C}^{**} -fibrations of $\mathbb{P}^2 \setminus \bar{E}$ given in the beginning of Section 4 relies on the classification result [PP17, Theorem 1.3]. Here we give a direct proof of this fact.

Proposition 4.18 (Complements are not \mathbb{C}^{**} -fibered). If $\bar{E} \subseteq \mathbb{P}^2$ is a rational cuspidal curve of one of the types listed in Definition 1.3 then $\mathbb{P}^2 \setminus \bar{E}$ admits no \mathbb{C}^{**} -fibration.

Proof. Suppose that $\mathbb{P}^2 \setminus \bar{E}$ has a \mathbb{C}^{**} -fibration. By [PP17, Proposition 3.3] we can choose one with no base point on X , where $\pi : (X, D) \rightarrow (\mathbb{P}^2, \bar{E})$ is the minimal log resolution. Then this fibration extends to a \mathbb{P}^1 -fibration $X \rightarrow \mathbb{P}^1$ such that $F \cdot D = 3$ for every fiber F . We use Notation 2.3 and for the components of D we use the notation introduced at the beginning of Section 4. In particular, $E = \pi_*^{-1}\bar{E}$, $Q'_j = \pi^{-1}(q_j)_{\text{red}}$ for $j \in \{1, \dots, c\}$ and C'_j is the last component of Q'_j , that is, the unique (-1) -curve in Q'_j . Recall also that for types listed in Definition 1.3 we have $c \in \{2, 3, 4\}$ and $E^2 \leq -3$, see Table 1.

Claim 1. For every $j \in \{1, \dots, c\}$ the divisor $E + C'_j$ is not vertical.

Proof. Suppose that $E + C'_j$ is contained in some fiber, say, F_E . Because $\beta_D(C'_j) = 3$ and because fibers of \mathbb{P}^1 -fibrations contain no branching (-1) -curves, we have $C'_j \cdot D_{\text{hor}} \geq 1$, and if the equality holds then

C'_j is not a tip of F_E , so its multiplicity $\mu(C'_j)$ in F_E is at least 2. In any case, we get $\mu(C'_j)C'_j \cdot D_{\text{hor}} \geq 2$. It follows that $C'_{j'}$ is horizontal for $j' \neq j$ and

$$\mu(C'_j)C'_j \cdot D_{\text{hor}} \leq (F_E - E) \cdot D_{\text{hor}} = 3 - (c - 1) \leq 2,$$

so the equalities hold. In particular, $c = 2$ and D_{hor} meets F_E only in $C'_j + E$. Since D is connected, every connected component of D_{vert} meets D_{hor} , so the set $F_E \cap D$ is connected. As a consequence, $F_E \subseteq D$: indeed, if F_E has a component $L \not\subseteq D$ then $L \cdot D_{\text{hor}} = 0$ and, since F_E is a rational tree, $L \cdot D_{\text{vert}} = 1$ and $L \cong \mathbb{P}^1$, contrary to Lemma 2.5. We have $E \cdot (D_{\text{vert}} - C'_j) = 0$. If C'_j is a tip of F_E then $F_E = C'_j + E = [1, 1]$ and if C'_j is not a tip of F_E then $\mu(C'_j) = 2$ and, since C'_j is the unique (-1) -curve in F_E , $F_E = [2, 1, 2]$. In both cases we get a contradiction with $E^2 \leq -3$. \square

Claim 2. The curve E is horizontal and D contains no fiber.

Proof. Suppose that E is contained in some fiber, say F_E . It follows from Claim 1 that $C'_1 + \dots + C'_c$ is horizontal, so D_{vert} has no (-1) - or 0-curves. In particular, D contains no fiber. Recall that E meets $D - E$ only in C'_1, \dots, C'_c . As a consequence, $3 = F_E \cdot D_{\text{hor}} \geq \mu(E)E \cdot D_{\text{hor}} = \mu(E)c \geq 2\mu(E)$, so $\mu(E) = 1$ and $(F_E - E) \cdot D_{\text{hor}} = 3 - c$. The connectedness of D gives

$$b_0((F_E - E) \cap D) \leq (F_E - E) \cdot D_{\text{hor}} = 3 - c \leq 1,$$

so $(F_E - E) \cap D$ is connected. For every component L of F_E not contained in D_{vert} we have $L \cong \mathbb{P}^1$, so $L \cdot D \geq 2$ by Lemma 2.5. Because the fiber F_E has no loops, such L is unique and meets D_0 in E and in $(F_E - E) \cap D$. In particular, the latter set is nonempty, so the above inequalities imply that $c = 2$. There is no (-1) -curve in D_{vert} , so L is a unique (-1) -curve in F_E . In particular, $\mu(L) \geq 2$. Both connected components of $F_E \cap D$ meet sections in D , so they contain components of multiplicity 1. Lemma 2.2(b) implies that F_E is a chain of type $[\gamma, 1, (2)_{\gamma-1}]$, where $\gamma = -E^2 \geq 3$, and meets D_{hor} in tips. Thus D contains a twig $V = [(2)_{\gamma-1}]$ and L meets $\text{tip}^+(V)$. Because $c = 2$, \bar{E} is of type \mathcal{H}, \mathcal{I} or \mathcal{J} . In the first case (see Figure 17) the existence of V implies that $\gamma = 3$ and that V meets C'_1 , so $\pi(L)^2 = 6$; a contradiction. In the second case (see Figure 13) we get that V meets C'_1 and $\pi(L)^2 = 10$; a contradiction. In the third case (see Figure 18) $\text{tip}^+(V)$ is either the first component of Q'_1 , or, if $k \geq 3$, the fourth component of Q'_1 or the second component of Q'_2 . We get $\pi(L)^2 = 0, 3, 1$, respectively, so the last case holds. Then $\pi(L)$ is a line and $\deg \bar{E} = (\pi(L) \cdot \bar{E})_{q_2} + 1 = 2k + 3$. But $\deg \bar{E} = 4k + 1$, so $k = 1$; a contradiction. The second assertion follows because the intersection matrix of $D_{\text{vert}} \subseteq D - E$ is negative definite. \square

Claim 3. The curve E is a 1-section.

Proof. Claim 2 and Lemma 2.4 imply that E is not a 3-section. Suppose that E is a 2-section. Then $H := D_{\text{hor}} - E$ is a section contained in, say, Q'_{j_0} for some $j_0 \in \{1, \dots, c\}$. Consequently, Q'_j is vertical for every $j \neq j_0$. The restriction $p|_E: E \rightarrow \mathbb{P}^1$ has degree 2 and is ramified at every $E \cap C'_j$ for $j \neq j_0$, so the Hurwitz formula gives $c \leq 3$. For $j \neq j_0$ let F_j be the fiber containing Q'_j and let μ_j be the multiplicity of $q_j \in \bar{E}$. Because our \mathbb{P}^1 -fibration factors through the contraction of Q'_j , say π_j , the divisor $F_j - \pi_j^{-1}(q_j)$ is effective, so the projection formula gives $2 \leq \mu_j = \pi_j^{-1}(q_j) \cdot E \leq F_j \cdot E = 2$. It follows that $\mu_j = 2$ and F_j meets E only in Q'_j , so $C'_{j'} \not\subseteq F_j$ for $j' \neq j$. Because \bar{E} has at most three cusps and at most one of them is not semi-ordinary, \bar{E} is of type \mathcal{Q}_3 (see Table 1) and we may assume that $j_0 = 1$. By Lemma 2.4 for $j \in \{2, 3\}$ there is a unique component of F_j not contained in D_{vert} , say L_j . Then

$$2 \geq \mu(\pi_j(L_j))\pi_j(L_j) \cdot \pi_j(E) \geq \mu(L_j)\mu_j = 2\mu(L_j),$$

so equalities hold. In particular, $\mu(L_j) = 1$ and $\pi_j(L_j)$ is not tangent to $\pi_j(E_j)$, so L_j meets the first component of Q'_j . The image of $F_j - L_j$ contains no (-1) -curves, so $\pi_j(F_j) = [0]$, hence $L_j^2 = -1$ and $(F_j)_{\text{red}} = L_j + Q'_j$. We have $H \subseteq Q'_1 = [2, 3, 1, 2]$. The connected components of $Q_1 - H$ are contained in different fibers, other than F_2 and F_3 . It follows that H is a tip of Q'_1 , for otherwise one of those connected components is a (-2) -curve and the fiber containing it has at least two components not contained in D_{vert} , contrary to Lemma 2.4. Recall that L_2 satisfies $L_2^2 = -1$, $L_2 \cdot D = 2$ and L_2 meets D in H and in the first component of Q'_2 . It follows that H is in fact the first component of Q'_1 . Indeed, otherwise the contractions of Q'_1 and Q'_2 touch L_2 three times and once, respectively, so $\pi(L_2)^2 = 3$, which is impossible. Therefore, $\pi(L_2)^2 = 1$, so $\pi(L_2)$ is a line and

$$5 = \deg \bar{E} = \bar{E} \cdot \pi(L_2) = (\bar{E} \cdot \pi(L_2))_{q_1} + (\bar{E} \cdot \pi(L_2))_{q_2} = 2 + 2;$$

a contradiction. \square

If for some $j \in \{1, \dots, c\}$ the curve C'_j is vertical then we denote by F_j the fiber containing it. In this case $\mu(C'_j) = 1$, because C'_j meets E , so C'_j is a tip of F_j . We infer that for every $j \in \{1, \dots, c\}$, $(Q'_j)_{\text{hor}}$ contains C'_j or a component of Q'_j meeting C'_j . Since $c \geq 2$, we see that $c = 2$ and $D_{\text{hor}} - E$ consists of two 1-sections, one in each Q'_j . The curve $\bar{E} \subseteq \mathbb{P}^2$ is of type \mathcal{H} , \mathcal{I} or \mathcal{J} . We check that in all three cases (see Figures 17, 13 and 18), every C'_j meets a unique twig of D , say V_j , which is in fact a (-2) -twig, and that the component B_1 of $Q'_1 - V_1$ meeting C'_1 is branching in Q'_1 .

Claim 4. For every $j \in \{1, \dots, c\}$, either the curve C'_j is horizontal or $F_j = C'_j + V_j + L_j = [1, 2, \dots, 2, 1]$, where L_j is a unique component of F_j not contained in D_{vert} .

Proof. Assume C'_j is vertical. Note that $C'_{3-j} \not\subseteq F_j$, because otherwise $F_j \cdot E \geq 2$, which is false. Since C'_j meets two sections in D_{hor} , the connectedness of D implies that the set $F_j \cap D$ has at most two connected components. Since F_j is a rational tree, Lemma 2.5 implies that $\sigma(F_j) = 1$ and $b_0(F_j \cap D) = 2$. Because $\mu(C'_j) = 1$ and $(F_j - C'_j) \wedge D_{\text{vert}}$ contains no (-1) -curves, we have $L_j^2 = -1$. Since both connected components of $F_j \cap D$ contain (or belong to, in case some of them is a point) a component of multiplicity 1 in F_j , we infer that F_j is a chain meeting D_{hor} in tips. Therefore, F_j contains a twig of D meeting C'_j , namely the (-2) -twig V_j . Because F_j contracts to a 0-curve, we get $F_j = C'_j + V_j + L_j$, as claimed. \square

Claim 4 implies for instance that the section contained in Q'_1 is C'_1 or B_1 . Because $\beta_{Q'_1}(B_1) = 3$, in any case we get that $(Q'_1)_{\text{vert}}$ has at least two connected components with no (-1) -curves, lying in different fibers. Lemma 2.4 implies that one of these fibers, say F , has a unique component not contained in D_{vert} , say L_F . From Claim 4 we infer that $F \neq F_1, F_2$, so $C'_1, C'_2 \not\subseteq F$. Hence, L_F is a unique (-1) -curve in F and $(F \wedge D_{\text{vert}}) \cdot E = 0$, so E meets F in L_F . But $\mu(L_F) \geq 2$ and E is a 1-section by Claim 3; a contradiction. \square

5. GEOMETRIC CONSEQUENCES

5A. Proof of Theorem 1.4.

Theorem 1.2 and [PP17, Theorem 1.3] describe the possible types of $\bar{E} \subseteq \mathbb{P}^2$. In particular, since \bar{E} is not an Orevkov curve, it has at least two cusps. We order those cusps as in Lemma 4.2. Let ℓ_{12} and ℓ_1 be the lines defined there.

Claim 1. We may assume that \bar{E} is of type \mathcal{G} , \mathcal{J} , \mathcal{Q}_3 or \mathcal{Q}_4 .

Proof. Assume that \bar{E} is not of one of the above types. By Lemma 4.2(a) the line ℓ_{12} joining q_1 with q_2 meets \bar{E} in exactly two points. If \bar{E} is of one of the types listed in Theorem 1.4(a) then by Lemma 4.2(b) the line ℓ_1 tangent to $q_1 \in \bar{E}$ meets $\bar{E} \setminus \{q_1\}$ exactly once and transversally. In particular, $\ell_1 \neq \ell_{12}$ is another line through q_1 meeting \bar{E} in exactly two points. Thus we may assume that \bar{E} is of type \mathcal{E} , \mathcal{F} or \mathcal{I} . We need to show that part (c) of Theorem 1.4 holds. Using the parameterization of \bar{E} given by [BZ10, (t) or (s)], see [PP17, Remark 4.14] and Remark 4.17(a), we check that any line through q_1 other than ℓ_{12} meets $\bar{E} \setminus \{q_1\}$ in at least two points. Hence, ℓ is unique. Suppose that $u \subseteq \mathbb{P}^2$ is a curve such that $u \setminus \ell_{12} \cong \mathbb{C}^1$ and $(u \setminus \ell_{12}) \cdot (\bar{E} \setminus \ell_{12}) = 1$. Then $u \cap \ell_{12} = \{q_j\}$ for some $j \in \{1, 2\}$. If u is a line then $(u \cdot \bar{E})_{q_j} = \deg \bar{E} - 1$ is the sum of some number of initial terms of the multiplicity sequence of $q_j \in \bar{E}$. But we check directly (see [PP17, Table 1] and Table 1) that the latter is impossible, hence u is (a conic or a rational unicuspidal curve) tangent to ℓ_{12} at q_j . Because by Lemma 4.2(b) \bar{E} is not, the number $(u \cdot \bar{E})_{q_j} = \deg u \cdot \deg \bar{E} - 1$ is the product of multiplicities of $q_j \in u$ and $q_j \in \bar{E}$. Hence, $\deg u \cdot \deg \bar{E} - 1 \leq (\deg u - 1)(\deg \bar{E} - 1)$, so $\deg u + \deg \bar{E} \leq 2$; a contradiction. \square

Let us recall that a curve of type $\mathcal{G}(\gamma)$, $\gamma \geq 3$ has degree $2\gamma - 1$ and the multiplicity sequences of its cusps are $(\gamma - 1)_4$ and $(2)_{\gamma-1}$, see [PP17, Table 1].

Claim 2. If \bar{E} is of type \mathcal{G} then there exist unique non-degenerate conics m and m' such that $(m \cdot \bar{E})_{q_1} = 2 \deg \bar{E} - 1$, $(m' \cdot \bar{E})_{q_1} = 2 \deg \bar{E} - 2$ and $(m' \cdot \bar{E})_{q_2} = 2$.

Proof. The proof is similar to the one in Remark 4.15(b). Let ϑ be a composition of four blowups at $q_1 \in \bar{E}$ and its infinitely near points on the proper transforms of \bar{E} . Denote by V the last exceptional curve of ϑ . Lemma 4.2(b) implies that $(\vartheta_*^{-1}\ell_1)^2 = -1$ and $\vartheta_*^{-1}\ell_1 \cdot \vartheta_*^{-1}\bar{E} = 1$. The divisor $\text{Exc } \vartheta = [2, 2, 2, 1]$ meets $\vartheta_*^{-1}\ell_1$ only in the second component, transversally, and meets $\vartheta_*^{-1}\bar{E}$ only in V , with multiplicity $\gamma - 1$. Hence, $\vartheta_*^{-1}\ell_1 + \text{Exc } \vartheta - V$ supports a fiber F of a \mathbb{P}^1 -fibration such that $\vartheta_*^{-1}\bar{E}$ is a 2-section. Denote by F_1, F_2 the fibers passing through $V \cap \vartheta_*^{-1}\bar{E}$ and $\vartheta^{-1}(q_2)$, respectively. Lemma 2.4 implies that F is the

unique degenerate fiber, so F_1 and F_2 are smooth. This \mathbb{P}^1 -fibration restricts to a morphism $\vartheta_*^{-1}\bar{E} \rightarrow \mathbb{P}^1$ of degree 2, ramified at $\vartheta_*^{-1}\ell_1 \cap \vartheta_*^{-1}\bar{E}$ and at $\vartheta^{-1}(q_2)$. The Hurwitz formula implies that F_1 and F_2 are not tangent to $\vartheta_*^{-1}\bar{E}$. It follows that m, m' are the required conics if and only if they are images of F_1 and F_2 , respectively (see [PP17, Figure 11], where the proper transforms of m, m' on X are denoted by L_{F_1} and L_{F_2} , respectively). \square

From now on we assume that \bar{E} is as in Claim 1. Clearly, there exists at least one ℓ through q_1 meeting \bar{E} at two points, namely $\ell = \ell_1$. We will show in Claim 4 that this is the only possibility. First, we make the following reduction.

Claim 3. If \bar{E} is not of type \mathcal{G} and a line ℓ' meets $\bar{E} \setminus \ell_1$ in one point then \bar{E} is of type \mathcal{J} and $\ell' \cap \ell_1 \subseteq \bar{E} \setminus \{q_1\}$.

Proof. By Claim 1 \bar{E} is of type $\mathcal{J}, \mathcal{Q}_3$ or \mathcal{Q}_4 . By Lemma 4.2(b) ℓ_1 meets $\bar{E} \setminus \{q_1\}$ once and transversally. Let r be the unique common point of ℓ' and ℓ_1 . By Lemma 2.5 ℓ' meets \bar{E} in at least two points, so $r \in \bar{E}$. Denote by μ the multiplicity of $r \in \bar{E}$. Let ϑ be a blowup at r . Then $|\vartheta_*^{-1}\ell'|$ induces a \mathbb{P}^1 -fibration which restricts to a morphism $g: \vartheta_*^{-1}\bar{E} \rightarrow \mathbb{P}^1$ of degree $\deg \bar{E} - \mu$. For a point $p \in \vartheta_*^{-1}\bar{E}$ denote by r_p the ramification index of g at p . For any line through r the sum of r_p for p contained in the proper transform of that line equals $\deg g$. Hence,

$$\sum_{p \in \vartheta_*^{-1}(\ell_1 + \ell')} (r_p - 1) = 2 \deg g - \#(\vartheta_*^{-1}(\ell_1 + \ell') \cap \vartheta_*^{-1}\bar{E}) \geq 2 \deg g - 3,$$

where the last inequality follows from the assumption. The Hurwitz formula gives

$$\sum_{p \notin \vartheta_*^{-1}(\ell_1 + \ell')} (r_p - 1) \leq 2 \deg g - 2 - (2 \deg g - 3) = 1.$$

Thus g has at most one ramification point off $\vartheta_*^{-1}(\ell_1 + \ell')$, and its ramification index is 2. Hence, \bar{E} has at most one cusp off $\ell_1 + \ell'$ and this cusp, if exists, has multiplicity 2. It follows that \bar{E} is of type \mathcal{J} or \mathcal{Q}_3 , and (after renaming the cusps q_2, \dots, q_c if necessary) $q_2 \in \ell'$. Consider the first case. If $q_1 \in \ell'$ then

$$(\ell' \cdot \bar{E})_{q_2} = \deg \bar{E} - (\ell' \cdot \bar{E})_{q_1} = 4k + 1 - 2k = 2k + 1$$

is a sum of some number of initial terms of the multiplicity sequence of $q_2 \in \bar{E}$. But from Table 1 we see that this is impossible, which proves the claim in this case. We are left with the case when \bar{E} is of type \mathcal{Q}_3 . If ℓ' is tangent to \bar{E} at q_2 then $(\ell' \cdot \bar{E})_{q_2} = 4$ and $(\ell' \cdot \bar{E})_r = 1$, so $\deg g = 4$ and g is ramified at $\vartheta^{-1}(q_3)$ and with index 4 at $\vartheta^{-1}(q_1)$ and $\vartheta^{-1}(q_2)$. Since the latter contradicts the Hurwitz formula, we infer that ℓ' is not tangent to \bar{E} at q_2 , so $(\ell' \cdot \bar{E})_r = 3$. By Lemma 4.2(b) and Remark 4.8, any line ℓ'' through q_j for $j \in \{1, 2, 3\}$ satisfies $(\ell'' \cdot \bar{E})_{q_j} \in \{2, 4\}$. Hence, r is a smooth point of \bar{E} . By Remark 4.8 there is an automorphism $\varepsilon \in \text{Aut}(\mathbb{P}^2, \bar{E})$ such that $\varepsilon(q_2) = q_1$. The line $\varepsilon(\ell')$ meets \bar{E} only in two points, namely in q_1 and $\varepsilon(r)$, hence \bar{E} has two cusps off $\varepsilon(\ell')$. But we have shown above that this is impossible; a contradiction. \square

Claim 4. If a line ℓ' meets $\bar{E} \setminus \ell_1$ in one point then $q_1 \notin \ell'$ and $q_2 \in \ell'$.

Proof. Either \bar{E} is of type \mathcal{G} or \bar{E} and ℓ' are as in Claim 3. In both cases Lemma 2.5 implies that ℓ' meets \bar{E} in at least two points, so $\ell' \cap \ell_1 \subseteq \bar{E}$. If $\ell' \cap \bar{E} = \{q_1, q_2\}$ then \bar{E} is of type \mathcal{G} and we put $P = \pi_*^{-1}(\ell_1 + \ell' + m')$, where m' is as in Claim 2. In other cases we put $P = \pi_*^{-1}(\ell_1 + \ell')$. Note that $D + P - \pi_*^{-1}\ell'$ is an snc divisor and $P - \pi_*^{-1}\ell'$ consists of disjoint (-1) -curves. Let

$$\pi': (X', D') \rightarrow (X, D + P)$$

be the minimal log resolution, $P' := (\pi')_*^{-1}P$ and let $(X', D') \rightarrow (\tilde{X}, \tilde{D})$ be the (unique) snc-minimalization of D' . We have $e_{\text{top}}(\tilde{X} \setminus \tilde{D}) = e_{\text{top}}(X \setminus (D + P)) = e_{\text{top}}(X \setminus D) = 1$, because $P \setminus D$ is a disjoint union of curves isomorphic to \mathbb{C}^* . Lemma 2.5 and [Fuj82, 6.24] imply that the negative part of the Zariski–Fujita decomposition of $K_{\tilde{X}} + \tilde{D}$ equals $\text{Bk } \tilde{D}$, that is, the sum of barks of all maximal twigs of \tilde{D} , see Section 2A. Put $\text{ind}(\tilde{D}) = -(\text{Bk } \tilde{D})^2 \geq 0$. Then the logarithmic Bogomolov–Miyaoka–Yau inequality reads as

$$(5.1) \quad (K_{\tilde{X}} + \tilde{D})^2 + \text{ind}(\tilde{D}) \leq 3.$$

We will rewrite it using properties of P and π' .

Since the morphism $X' \rightarrow \tilde{X}$ is a composition of blowups with centers at the nodes of successive reduced total transforms of \tilde{D} , we have $(K_{\tilde{X}} + \tilde{D})^2 = (K_{X'} + D')^2$. Moreover,

$$D' \cdot (K_{X'} + D') = 2p_a(D') - 2 = 2\#P - 2.$$

The non-nc points of $D + P$ are exactly the points of $\pi^{-1}(\ell' \cap \bar{E} \setminus \{q_1, q_2\})$. To see this, recall that $D + P - \pi_*^{-1}\ell'$ is snc. Since ℓ' is smooth, $\pi_*^{-1}\ell'$ meets $D - E$ transversally, off E , each component of $D - E$ at most once. By definition, $\pi_*^{-1}\ell'$ is disjoint from $P - \pi_*^{-1}(\ell_1 + \ell')$ and the common point of $\pi_*^{-1}\ell_1$ and $\pi_*^{-1}\ell'$, if exists, is contained in E , so it is not an nc point of $D - E$. Conversely, if $\pi_*^{-1}\ell'$ meets E transversally at some point r' then $r' \in \pi_*^{-1}\ell_1$, since otherwise $\ell' \cap \ell_1 = \{q_1\}$ and $(\ell' \cdot \bar{E})_{q_1} = \deg \bar{E} - 1 = (\ell_1 \cdot \bar{E})_{q_1}$, which is false. Let $\varepsilon := 2 - \#(\ell' \cap \{q_1, q_2\})$ be the number of non-nc points of $D + P$. Each of these points is resolved by a sequence of blowups such that the centers of all but the first one are the nodes of respective total reduced transforms of D , hence

$$K_{X'} \cdot (K_{X'} + D' - P') = K_X \cdot (K_X + D) - \varepsilon.$$

By [Pal19, Lemma 4.3(i)] $K_X \cdot (K_X + D) = h^0(2K_X + D)$, which in our cases vanishes, because $\kappa(K_X + \frac{1}{2}D) = -\infty$ (see [PP17, Lemma 4.4] and Proposition 4.4). Therefore, (5.1) reads as

$$(5.2) \quad K_{X'} \cdot P' + 2\#P + \text{ind}(\tilde{D}) \leq 5 + \varepsilon.$$

By the definition of a bark, the number $\text{ind}(\tilde{D})$ equals the sum of coefficients of $\text{tip}^+(W)$ in $\text{Bk}_{\tilde{D}}(W)$, taken over all maximal twigs W of \tilde{D} . Hence [Miy01, II.3.3.4] gives

$$\text{ind}(\tilde{D}) = \sum_W \frac{d(W - \text{tip}^+(W))}{d(W)},$$

where $d(W)$ is as in Section 2A. If W is a (-2) -twig then the respective summand is $\frac{\#W}{\#W+1} \geq \frac{1}{2}$. We claim that $\text{ind}(\tilde{D}) > 1$. To see this, note that the map $X \dashrightarrow \tilde{X}$ does not touch the maximal (-2) -twigs of D meeting C'_1, C'_2 (where C'_j is the last component of $Q'_j := \pi^{-1}(q_j)_{\text{red}}$, see the beginning of Section 4). If $q_1 \notin \ell'$ then it does not touch the first component of Q'_1 , whose image becomes a maximal (-2) -twig of \tilde{D} . If $q_1 \in \ell'$ then, since $(\ell' \cdot \bar{E})_{q_1} < (\ell_1 \cdot \bar{E})_{q_1} = \deg \bar{E} - 1$, ℓ' is tangent to \bar{E} at the other point of $\ell' \cap \bar{E}$, so the image of its resolution contains a twig of \tilde{D} . This proves $\text{ind}(\tilde{D}) > 1$. Now (5.2) gives $K_{X'} \cdot P' + 2\#P \leq 3 + \varepsilon$. Let L', L_1 and M' be the proper transforms on X' of ℓ', ℓ_1 and m' , respectively. They are smooth and rational, so

$$(5.3) \quad -3 - \varepsilon \leq (L')^2 + L_1^2 + (P' \wedge M')^2,$$

where $P' \wedge M' = M'$ or 0 depending on whether $\ell' \cap \bar{E} = \{q_1, q_2\}$ or not.

Suppose that $q_1 \in \ell'$. By Claim 3 the curve \bar{E} is of type $\mathcal{G}(\gamma)$ for some $\gamma \geq 3$. Since the centers of π' belong to $\pi_*^{-1}\ell'$, π' does not touch L_1 , so $L_1^2 = -1$. Since ℓ' is not tangent to \bar{E} at q_1 , the contraction of Q'_1 touches $\pi_*^{-1}\ell'$ exactly once. Consider the case $q_2 \in \ell'$. Then $\varepsilon = 0$, $P' \wedge M' = M'$ and $\pi' = \text{id}$. We have $(\ell' \cdot \bar{E})_{q_2} = \deg \bar{E} - (\ell' \cdot \bar{E})_{q_1} = \gamma$, so the contraction of Q'_2 touches L' exactly $\frac{1}{2}\gamma$ times, hence $(L')^2 = -\frac{1}{2}\gamma$. It follows from (5.3) that $\gamma \leq 2$; a contradiction. Consider the case $q_2 \notin \ell'$. Then $\varepsilon = 1$, $P' \wedge M' = 0$ and π' touches L' exactly $\deg \bar{E} - (\ell' \cdot \bar{E})_{q_1} = \gamma$ times, so $(L')^2 = -\gamma$ and hence $\gamma = 3$ by (5.3). The maximal twigs of \tilde{D} are: the (-2) -tips meeting the images of C'_1, C'_2 , the image of the other twig of D contained in Q'_2 , which is of type $[2, 3]$, and the maximal (-2) -twig contained in the preimage of $\ell' \cap \bar{E} \setminus \{q_1\}$. Hence, $\text{ind}(\tilde{D}) > 2$, which is in contradiction with (5.2).

Hence, $q_1 \notin \ell'$. Suppose that $q_2 \notin \ell'$. Then $\varepsilon = 2$. We have $P' \wedge M' = 0$ and π' touches L_1 exactly once, so $L_1^2 = -2$ and the inequality (5.3) reads as $(L')^2 \geq -3$. But π does not touch $\pi_*^{-1}\ell'$ and π' touches L' exactly $\deg \bar{E}$ times, so $-3 \leq (L')^2 = 1 - \deg \bar{E} \leq -4$; a contradiction. \square

Claim 4 implies in particular that ℓ as in Theorem 1.4 is unique, equal to ℓ_1 . Assume that $u \subseteq \mathbb{P}^2$ is a curve such that $u \setminus \ell_1 \cong \mathbb{C}^1$ and $(u \setminus \ell_1) \cdot (\bar{E} \setminus \ell_1) = 1$. By Claim 2 it remains to show that \bar{E} is of type \mathcal{G} and $u = m$.

Claim 5. The curve u is tangent to \bar{E} at q_1 . We may assume that it is singular.

Proof. Write $u \cap \ell_1 = \{r\}$. Since $u \cdot \bar{E} \geq 2$, we have $r \in \bar{E}$. By Claim 4, u is not a line, so either u is a conic or $r \in u$ is its unique singular point, a cusp. Denoting by ℓ_r the line tangent to u at r we get $\ell_1 \cdot u = (\ell_1 \cdot u)_r \leq (\ell_r \cdot u)_r \leq \ell_r \cdot u$, so the equalities hold and we have $\ell_r = \ell_1$. Suppose that $r \neq q_1$. By Lemma 4.2(b), ℓ_1 is not tangent to \bar{E} at r , so neither is u . Then the number $(u \cdot \bar{E})_r = \deg u \cdot \deg \bar{E} - 1$ is the product of multiplicities of $r \in u$ and $r \in \bar{E}$, hence $\deg u \cdot \deg \bar{E} - 1 \leq (\deg u - 1)(\deg \bar{E} - 1)$, so $\deg u + \deg \bar{E} \leq 2$; a contradiction. Thus u is tangent to \bar{E} at q_1 .

Assume that u is a conic. Then $(u \cdot \bar{E})_{q_1} = 2 \deg \bar{E} - 1$, so the latter is a sum of some number of initial terms of the multiplicity sequence of $q_1 \in \bar{E}$. Because u is smooth, at most two of these summands are

distinct. We check directly that this is possible only if \bar{E} is of type \mathcal{G} . Then Claim 2 implies that $u = m$. \square

By Claim 5 we may, and will, assume that u is a rational unicuspidal curve meeting ℓ_1 only in the cusp $q_1 \in u$. Let $\pi_u: (X_u, D_u) \rightarrow (\mathbb{P}^2, u)$ be the minimal log resolution.

Claim 6. We have a decomposition $\pi = \pi_u \circ \xi$ and ξ touches $\pi_*^{-1}u$.

Proof. Let U and E_u be the proper transforms on X_u of u and \bar{E} , respectively. The curve u is of Abhyankar–Moh–Suzuki type in the sense of [Ton00a]. By Theorem 1.1(iv) loc. cit. there exist integers $s \geq 0$, $k_1, \dots, k_{s+1} \geq 1$ such that putting $d_i = (k_{i+1} + 1) \cdot \dots \cdot (k_{s+1} + 1)$ for $i \in \{0, \dots, s\}$, we have $\deg u = d_0$ and $q_1 \in u$ has multiplicity sequence

$$(5.4) \quad (k_1 d_1, (d_1)_{2k_1}, \dots, k_s d_s, (d_s)_{2k_s}, k_{s+1}, (1)_{k_{s+1}})$$

(including all 1's in the end). Lemma 2.10(a) gives

$$U^2 = 3d_0 - 3 \sum_{i=1}^s k_i d_i - 2k_{s+1} - 2 = 3d_0 - 3 \sum_{i=1}^s (d_{i-1} - d_i) - 2d_s = d_s \geq 0.$$

Suppose first that U does not meet E_u on $\text{Exc } \pi_u$. Then $U \cdot E_u = 1$ and after $U^2 \geq 0$ blowups over $U \cap E_u$ the linear system of the proper transform of U induces a \mathbb{P}^1 -fibration which restricts to a \mathbb{C}^* -fibration of $\mathbb{P}^2 \setminus \bar{E}$. This gives $\kappa(\mathbb{P}^2 \setminus \bar{E}) \leq 1$; a contradiction.

The minimal log resolutions of the cusps $q_j \in \bar{E}$, $j \in \{2, \dots, c\}$ do not touch u , so it is enough to show that the common point of E_u and $\text{Exc } \pi_u$ is not a point of normal crossings of $E_u + \text{Exc } \pi_u$. Suppose it is. Since π_u is minimal, the last (-1) -curve in $\text{Exc } \pi_u$ meets two components of $D_u - U$. It follows that $q_1 \in \bar{E}$ and $q_1 \in u$ have the same multiplicity sequences. The last two terms (except the 1's) in the multiplicity sequence of $q_1 \in \bar{E}$ are equal (see Table 1), so in (5.4) we have $s \geq 1$ and $k_{s+1} = 1$, hence $d_s = 2$ and the sequence is $(2k_s, (2)_{2k_s}, 1, 1)$ if $s = 1$ or ends with

$$(k_{s-1} d_{s-1}, (d_{s-1})_{2k_{s-1}}, 2k_s, (2)_{2k_s}, 1, 1), \quad d_{s-1} = 2(k_s + 1)$$

if $s \geq 2$. Looking at Table 1 we see that this is possible only if $k_s = 1$ and $s = 1$. In this case \bar{E} is of type \mathcal{Q}_4 and $\deg u = d_0 = 4$. As a consequence, $(\bar{E} \cdot u)_{q_1} = \deg \bar{E} \cdot \deg u - 1 = 19$. We have $I(q_1) = 3 \cdot 4 + 2 \cdot 1 = 14$ (see Lemma 2.10), so U meets E_u on $\text{Exc } \pi_u$ with multiplicity $19 - I(q_1) = 5$. It follows that the minimal log resolution $\pi': (X', D') \rightarrow (X_u, D_u + E_u)$ is a composition of minimal log resolutions of the cusps $\pi_u^{-1}(q_j) \in E_u$, $j \in \{2, 3, 4\}$ with five blowups over the point of tangency of U and E_u on $\text{Exc } \pi_u$. We argue as in the proof of Claim 4. Because $u \setminus \bar{E} \cong \mathbb{C}^*$, we have

$$e_{\text{top}}(X' \setminus D') = e_{\text{top}}(\mathbb{P}^2 \setminus (\bar{E} + u)) = e_{\text{top}}(\mathbb{P}^2 \setminus \bar{E}) = 1.$$

Put $U' = (\pi')_*^{-1}U$. Since each of the five blowups touches the image of U' , we have $(U')^2 = (\deg u)^2 - I(q_1) - 5 = -3$, so D' is snc-minimal and $K_{X'} \cdot U' = -2 - (U')^2 = 1$. The center of each of those blowups is a node of the respective preimage of D , so as before we obtain $K_{X'} \cdot (K_{X'} + D' - U') = K_X \cdot (K_X + D) = 0$. This gives $(K_{X'} + D')^2 = K_{X'} \cdot U' + D' \cdot (K_{X'} + D') = 1$. The twigs of D' are exactly the proper transforms of the twigs of D , so $\text{ind}(D') = 3 \cdot \left(\frac{1}{3} + \frac{1}{2}\right) + \frac{1}{2} + \frac{5}{7} > 2$. This contradicts the log BMY inequality (see (5.1)). \square

Since u is singular and π_u is a minimal log resolution, the unique (-1) -curve V in $D_u - U$ meets U and two other components of D_u . By Claim 6, E_u meets $\text{Exc } \pi_u$ at the point $V \cap U$, which is the center of the next blowup in the decomposition of π . It follows that Q'_1 is not a chain, so \bar{E} is of type $\mathcal{J}(k)$ for some $k \geq 2$. The divisor D_u is snc, so the proper transform of U on X meets a tip of Q'_1 , the same as C'_1 (see Figure 19). As a consequence, the multiplicity sequence of $q_1 \in u$ equals $(k)_3$, we have $\deg u = u \cdot \ell_1 = (u \cdot \ell_1)_{q_1} = 2k$ and

$$u \cdot \bar{E} - 1 = (u \cdot \bar{E})_{q_1} = 3 \cdot 2k \cdot k + k \cdot 2 \cdot 1 + 1 = 6k^2 + 2k + 1.$$

Then $2k \cdot (4k + 1) = \deg u \cdot \deg \bar{E} = 6k^2 + 2k + 2$, so $k = 1$; a contradiction. \square

5B. Log deformations and the proof of Theorem 1.6.

We recall some results on logarithmic deformations. Let T be an snc divisor on a smooth projective surface V . The deformation theory of the pair (V, T) is described in terms of the cohomology of the logarithmic tangent sheaf $\mathcal{T}_V(-\log T)$, that is, the sheaf of those \mathcal{O}_V -derivations which preserve the ideal sheaf of T . The number $h^1(\mathcal{T}_V(-\log T))$ is the number of moduli for log deformations of the pair (V, T) and $H^2(\mathcal{T}_V(-\log T))$ is the space of obstructions for extending infinitesimal deformations, see [FZ94, Lemma 1.1]. We need the following lemma.

Lemma 5.1 (Properties of $\mathcal{T}_V(-\log T)$, [FZ94]). Let S be a smooth surface and let (V, T) be some log smooth completion of S . Then

- (a) The number $h^2(\mathcal{T}_V(-\log T))$ depends only on S .
- (b) If $L \subseteq T$ is a (-1) -curve then $h^i(\mathcal{T}_V(-\log(T-L))) = h^i(\mathcal{T}_V(-\log T))$ for $i \geq 0$.
- (c) If V admits a \mathbb{P}^1 -fibration such that $F \cdot T \leq 3$ for a fiber F then $H^2(\mathcal{T}_V(-\log T)) = 0$.
- (d) $\chi(\mathcal{T}_V(-\log T)) = K_V \cdot (K_V + T) + 2\chi(\mathcal{O}_V) - e_{\text{top}}(V) + r - \sum_{i=1}^r p_a(T_i)$, where T_1, \dots, T_r are the components of T .
- (e) If S is \mathbb{Q} -acyclic then $\chi(\mathcal{T}_V(-\log T)) = K_V \cdot (K_V + T)$.

Proof. (a), (b), (c) are shown in [FZ94, Lemma 1.5(5) and Propositions 1.7(3), 6.2].

(d) Since T is snc, the exact sequence [Kaw78, Proposition 1(2)] reads as

$$0 \longrightarrow \mathcal{T}_V(-\log T) \longrightarrow \mathcal{T}_V \longrightarrow \bigoplus_{i=1}^r \mathcal{N}_{T_i/V} \longrightarrow 0,$$

so $\chi(\mathcal{T}_V(-\log T)) = \chi(\mathcal{T}_V) - \sum_{i=1}^r \chi(\mathcal{N}_{T_i/V})$. We have $c_2(\mathcal{T}_V) = e_{\text{top}}(V)$ and $-c_1(\mathcal{T}_V) = c_1(\Omega_V^1) = c_1(\Lambda^2 \Omega_V^1) = K_V$, hence using the Riemann-Roch theorem and the Noether formula we get $\chi(\mathcal{T}_V) = 2\chi(\mathcal{O}_V) + K_V^2 - e_{\text{top}}(V)$. Since $\mathcal{N}_{T_i/V} \cong \mathcal{O}_{T_i}(T_i^2)$, the Riemann-Roch theorem and the adjunction formula give

$$\chi(\mathcal{N}_{T_i/V}) = \chi(\mathcal{O}_{T_i}(T_i^2)) = T_i^2 - p_a(T_i) + 1 = p_a(T_i) - K_V \cdot T_i - 1.$$

(e) [FZ94, Lemma 1.3(5)]. If $V \setminus T$ is \mathbb{Q} -acyclic then V is rational, the components of T are rational and freely generate $H_2(V, \mathbb{Q})$. We obtain $\chi(\mathcal{O}_V) = 1$ and $e_{\text{top}}(V) = 2 + r$. Thus (e) follows from (d). \square

In [FZ94] Flenner and Zaidenberg made the following conjecture (cf. [Zai95, 1.3]).

Conjecture 5.2 (The Strong Rigidity Conjecture). Let S be a \mathbb{Q} -acyclic surface of log general type. Then for a minimal log smooth completion (X, D) of S we have $H^i(\mathcal{T}_X(-\log D)) = 0$ for $i \geq 0$.

As discussed in [Pal19, Conjecture 2.6], Negativity Conjecture 1.1 implies the Weak Rigidity Conjecture, which asserts that $\chi(\mathcal{T}_X(-\log D)) = 0$. A posteriori, from our classification we can deduce the following stronger result for \mathbb{Q} -acyclic surfaces which are complements of planar rational cuspidal curves.

Proposition 5.3 (Negativity implies Strong Rigidity). Let $\bar{E} \subseteq \mathbb{P}^2$ be a rational cuspidal curve such that $\mathbb{P}^2 \setminus \bar{E}$ is of log general type. If $\bar{E} \subseteq \mathbb{P}^2$ satisfies Negativity Conjecture 1.1 then it satisfies Strong Rigidity Conjecture 5.2.

Proof. Since $X \setminus D$ is of log general type, by [Lit82, Theorem 11.12] $\text{Aut}(X, D)$ is finite, so (X, D) has no infinitesimal automorphisms, that is, $H^0(\mathcal{T}_X(-\log D)) = 0$. Hence by Lemma 5.1(e)

$$h^2(\mathcal{T}_X(-\log D)) - h^1(\mathcal{T}_X(-\log D)) = \chi(\mathcal{T}_X(-\log D)) = K_X \cdot (K_X + D) = h^0(2K_X + D) \geq 0,$$

where the last equality follows from [Pal19, Lemma 4.3(i)]. Hence it suffices to show that

$$(5.5) \quad H^2(\mathcal{T}_X(-\log D)) = 0.$$

If $\mathbb{P}^2 \setminus \bar{E}$ has a \mathbb{C}^{**} -fibration then it extends to a \mathbb{P}^1 -fibration of some blowup of X , in which case (5.5) follows from Lemma 5.1(a),(c). Therefore, by Theorem 1.2 we may assume that $\bar{E} \subseteq \mathbb{P}^2$ is of one of the types listed in Definition 1.3. For types \mathcal{Q}_3 , \mathcal{Q}_4 or \mathcal{FZ}_2 the equality (5.5) follows from [FZ00, Corollary 2.4], so it remains to consider the types \mathcal{FE} , \mathcal{H} , \mathcal{I} and \mathcal{J} . We use the notation from the beginning of Section 4, in particular, for $j \in \{1, \dots, c\}$ we denote by C'_j the unique (-1) -curve in $Q'_j = \pi^{-1}(q_j)_{\text{red}}$.

Consider the types \mathcal{FE} and \mathcal{H} (see Figures 12, 17). Let A, A' be the proper transforms on X of the lines ℓ_{12}, ℓ_1 from Lemma 4.2. We have $(A')^2 = A^2 = -1$ and $A' \cdot D = A \cdot D = 2$. Moreover, A meets D only in the first components of Q'_1 and Q'_2 and A' meets D only in E and in the second component of Q'_1 .

For $j \in \{1, 2\}$ denote by B_j the branching component of Q'_j and by T'_j the (-2) -twig of Q'_j meeting B_j (cf. Notation 2.6). Let $\psi': (X, D + A + A') \rightarrow (X', D')$ be an snc-minimalization. By Lemma 5.1(a),(b)

$$h^2(\mathcal{T}_X(-\log D)) = h^2(\mathcal{T}_X(-\log(D + A + A'))) = h^2(\mathcal{T}_{X'}(-\log D')) = h^2(\mathcal{T}_{X'}(-\log(D' - \psi'(B_1)))),$$

where the last equality holds since in both cases $\psi'(B_1)$ is a (-1) -curve. We have

$$\psi'_*(Q'_2 - T'_2) = [2, 1, 2] \text{ for type } \mathcal{FE} \text{ and } \psi'_*(Q'_2 - T'_2) = [1, 3, 1, 2] \text{ for type } \mathcal{H}.$$

Each of these chains supports a fiber F of a \mathbb{P}^1 -fibration of X' which is met by $(D' - \psi'(B_1))_{\text{hor}}$ once in $\psi'(C'_2)$ and once in $\psi'(B_2)$. We have $\mu(\psi'(C'_2)) = 2$ and $\mu(\psi'(B_2)) = 1$ (where $\mu(C)$ denotes the multiplicity of C in F), so $F \cdot (D' - \psi'(B_1)) = 3$. Hence (5.5) follows from Lemma 5.1(c).

We are left with the types \mathcal{I} and \mathcal{J} (see Figures 13, 19). Let V_1 be the (-2) -twig of D meeting C'_1 . As before, Lemma 5.1(b) gives

$$h^2(\mathcal{T}_X(-\log D)) = h^2(\mathcal{T}_X(-\log(D - C'_2))).$$

Consider the type \mathcal{I} . Then $V_1 + C'_1 + E = [2, 2, 1, 3]$ supports a fiber F of a \mathbb{P}^1 -fibration of X which is met $(D - C'_2)_{\text{hor}}$ only once, in C'_1 . Since $\mu(C'_1) = 3$, we have $F \cdot (D - C'_2) = 3$ and again we deduce (5.5) from Lemma 5.1(c). Consider the type \mathcal{J} . Let A'' be the proper transform of the line ℓ_1 from Lemma 4.2. Then $(A'')^2 = -1$, $A'' \cdot D = 2$ and A'' meets D only in E and in the second component of Q'_1 . Now $V_1 + C'_1 + E + A'' = [2, 1, 3, 1]$ supports a fiber F of a \mathbb{P}^1 -fibration of X which is met by $(D - C'_2)_{\text{hor}}$ only once in C'_1 and once in A'' . Since $\mu(C'_1) = 2$ and $\mu(A'') = 1$, we have $F \cdot (D - C'_2) = 3$ and (5.5) follows again from Lemma 5.1(c). \square

Proof of Theorem 1.6.

(a) If $\kappa := \kappa(\mathbb{P}^2 \setminus \bar{E}) = -\infty$ then by [Miy01, Theorem 3.1.3.2] $\mathbb{P}^2 \setminus \bar{E}$ has a \mathbb{C}^1 -fibration. If $\kappa \in \{0, 1\}$ then [Pal19, Proposition 2.6] implies that $\mathbb{P}^2 \setminus \bar{E}$ has a \mathbb{C}^* -fibration, which by [PP17, Proposition 4.2] can be chosen without base points on X . Assume $\kappa = 2$. If $\mathbb{P}^2 \setminus \bar{E}$ has a \mathbb{C}^{**} -fibration then by [PP17, Proposition 4.2] it has one with no base point on X . In the other case, Proposition 4.4 gives a \mathbb{C}^{***} -fibration of $\mathbb{P}^2 \setminus \bar{E}$ with no base point on X . Because $\mathbb{P}^2 \setminus \bar{E}$ is rational, the base of each of the above fibrations is rational, and hence an open subset of \mathbb{P}^1 . The components of D are linearly independent in $\text{NS}_{\mathbb{Q}}(X)$, so after possibly resolving a base point in case of a \mathbb{C}^1 -fibration, the preimage of D contains at most one fiber. Hence the base is in fact \mathbb{P}^1 or \mathbb{C}^1 .

(b) If \bar{E} has at least three cusps then $\kappa = 2$ by [Wak78], so (b) follows from [PP17, Theorem 1.2] and Theorem 1.2; see (4.8) for the parameterization.

(c) If $\kappa = 2$ then (c) follows from Theorem 1.4. Assume $\kappa \leq 1$. If \bar{E} has at least two cusps then by [Wak78, Tsu81] it has exactly two and $\kappa = 1$. Then by [Ton00b, Theorem 4.1.1] there is a line meeting \bar{E} in exactly one point.

(d) The case $\kappa = 2$ is treated in Proposition 5.3, so we may assume that $\kappa \leq 1$. By [Pal19, Proposition 2.6] some log resolution of $(X', D') \rightarrow \mathbb{P}^2 \setminus \bar{E}$ has a \mathbb{P}^1 -fibration such that $F \cdot D' \leq 2$ for a fiber F . Then (d) follows from Lemma 5.1(a),(c). \square

In Table 1 below we summarize numerical data for rational cuspidal curves satisfying (2.9). For each cusp we list both its multiplicity sequence and a sequence of *Hamburger-Noether pairs*. We write the latter in the standard way in the sense of [PP17, Section 2D]. The sequence of Hamburger-Noether pairs is a convenient replacement of the sequence of multiplicities or of the Puiseux pairs (see [Rus80] for a detailed treatment). It is more directly related to the geometry of the resolution. Relations between those sequences are explained in [PP17, Lemmas 2.11 and 5.1].

	c	degree	$-E^2$	(standard) HN pairs	multiplicity sequences	parameters	references
\mathcal{Q}_3	3	5	5	$\binom{5}{2}, \binom{5}{2}, \binom{5}{2}$	$(2, 2), (2, 2), (2, 2)$		[Nam84, 2.3.10.8]
\mathcal{Q}_4	4	5	7	$\binom{7}{2}, \binom{3}{2}, \binom{3}{2}, \binom{3}{2}$	$(2, 2, 2), (2), (2), (2)$		[Nam84, 2.3.10.6]
$\mathcal{FE}(\gamma)$	3	$3\gamma - 5$	γ	$\binom{3\gamma-6}{3\gamma-9} \binom{3}{1}, \binom{4\gamma-10}{4} \binom{2}{1}, \binom{3}{2}$	$(3(\gamma-3), (3)_{\gamma-3}, ((4)_{\gamma-3}, 2, 2), (2)$	$\gamma \geq 5$	[Fen99], [BZ10, (h)]
$\mathcal{FZ}_2(\gamma)$	3	$2\gamma - 1$	γ	$\binom{2\gamma-2}{2\gamma-4} \binom{2}{1}, \binom{3\gamma-5}{3}, \binom{3}{2}$	$(2(\gamma-2), (2)_{\gamma-2}, ((3)_{\gamma-2}), (2)$	$\gamma \geq 4$	[FZ00], [BZ10, (g)]
$\mathcal{H}(\gamma)$	2	$3\gamma + 1$	γ	$\binom{3\gamma}{3\gamma-3} \binom{3}{1}, \binom{4\gamma-2}{4} \binom{2}{3}$	$(3(\gamma-1), (3)_{\gamma-1}, ((4)_{\gamma-1}, 2, 2, 2)$	$\gamma \geq 3$	[CNKR09, (ii.3)], [BZ10, (i)]
\mathcal{I}	2	14	3	$\binom{15}{6} \binom{3}{1}, \binom{12}{8} \binom{4}{2} \binom{2}{1}$	$(6, 6, 3, 3), (8, 4, 4, 2, 2)$		[BZ10, (t)], [KP16, (c)]
$\mathcal{J}(k)$	2	$4k + 1$	3	$\binom{6k+2}{2k} \binom{2}{1}, \binom{2k+2}{2k} \binom{2}{1}$	$(2k, 2k, 2k, (2)_k), (2k, (2)_k)$	$k \geq 2$	[tD95, IV], [Bod16b, (c)], Section 4D

TABLE 1. Numerical data for rational cuspidal curves satisfying (2.9), that is, satisfying Negativity Conjecture 1.1 and having a complement of log general type which does not admit a \mathbb{C}^{**} -fibration.

REFERENCES

- [AC02] Maria Alberich-Carramiñana, *Geometry of the plane Cremona maps*, Lecture Notes in Mathematics, vol. 1769, Springer-Verlag, Berlin, 2002.
- [Bod16a] József Bodnár, *Classification of rational unicuspidal curves with two Newton pairs*, Acta Math. Hungar. **148** (2016), no. 2, 294–299.
- [Bod16b] ———, *Construction of bicuspidal rational complex projective plane curves*, [arXiv:1608.02921](https://arxiv.org/abs/1608.02921), 2016.
- [BZ10] Maciej Borodzick and Henryk Żołądek, *Complex algebraic plane curves via Poincaré-Hopf formula. II*, Annuli, Israel J. Math. **175** (2010), 301–347, [arXiv:0708.1661](https://arxiv.org/abs/0708.1661).
- [CNKR09] Pierrette Cassou-Nogues, Mariusz Koras, and Peter Russell, *Closed embeddings of \mathbb{C}^* in \mathbb{C}^2 . I*, J. Algebra **322** (2009), no. 9, 2950–3002.
- [Fen99] Torsten Fenske, *Rational cuspidal plane curves of type $(d, d - 4)$ with $\chi(\Theta_V(D)) \leq 0$* , Manuscripta Math. **98** (1999), no. 4, 511–527.
- [Fuj82] Takao Fujita, *On the topology of noncomplete algebraic surfaces*, J. Fac. Sci. Univ. Tokyo Sect. IA Math. **29** (1982), no. 3, 503–566.
- [FZ94] Hubert Flenner and Mikhail Zaidenberg, *\mathbb{Q} -acyclic surfaces and their deformations*, Classification of algebraic varieties (L'Aquila, 1992), Contemp. Math., vol. 162, Amer. Math. Soc., Providence, RI, 1994, pp. 143–208.
- [FZ96] ———, *On a class of rational cuspidal plane curves*, Manuscripta Math. **89** (1996), no. 4, 439–459.
- [FZ00] ———, *Rational cuspidal plane curves of type $(d, d - 3)$* , Math. Nachr. **210** (2000), 93–110.
- [Iit82] Shigeru Iitaka, *Algebraic geometry*, Graduate Texts in Mathematics, vol. 76, Springer-Verlag, New York, 1982, An introduction to birational geometry of algebraic varieties, North-Holland Mathematical Library, 24.
- [Kas87] Hiroko Kashiwara, *Fonctions rationnelles de type $(0, 1)$ sur le plan projectif complexe*, Osaka J. Math. **24** (1987), no. 3, 521–577.
- [Kaw78] Yujiro Kawamata, *On deformations of compactifiable complex manifolds*, Math. Ann. **235** (1978), no. 3, 247–265.
- [KP16] Mariusz Koras and Karol Palka, *Classification of sporadic \mathbb{C}^* -embeddings into \mathbb{C}^2* , preprint, 2016.
- [KP17] ———, *The Coolidge-Nagata conjecture*, Duke Math. J. **166** (2017), no. 16, 3085–3145.
- [KPR16] Mariusz Koras, Karol Palka, and Peter Russell, *The geometry of sporadic \mathbb{C}^* -embeddings into \mathbb{C}^2* , J. Algebra **456** (2016), 207–249.
- [Miy01] Masayoshi Miyanishi, *Open algebraic surfaces*, CRM Monograph Series, vol. 12, American Mathematical Society, Providence, RI, 2001.
- [Moe08] Torgunn Karoline Moe, *Rational cuspidal curves*, M.Sc. thesis, [arXiv:1511.02691](https://arxiv.org/abs/1511.02691), 2008.
- [MT92] Masayoshi Miyanishi and Shuichiro Tsunoda, *Absence of the affine lines on the homology planes of general type*, J. Math. Kyoto Univ. **32** (1992), no. 3, 443–450.
- [Nam84] Makoto Namba, *Geometry of projective algebraic curves*, Monographs and textbooks in pure and applied mathematics, M. Dekker, 1984.
- [Ore02] Stepan Yu. Orevkov, *On rational cuspidal curves*, Math. Ann. **324** (2002), no. 4, 657–673.
- [Pal14] Karol Palka, *The Coolidge–Nagata conjecture, part I*, Adv. Math. **267** (2014), 1–43.
- [Pal15] ———, *A new proof of the theorems of Lin-Zaidenberg and Abhyankar-Moh-Suzuki*, J. Algebra Appl. **14** (2015), No. 9.
- [Pal19] ———, *Cuspidal curves, minimal models and Zaidenberg’s finiteness conjecture*, J. Reine Angew. Math. **747** (2019), 147–174.
- [Pio07] Jens Piontkowski, *On the number of cusps of rational cuspidal plane curves*, Experiment. Math. **16** (2007), no. 2, 251–256.
- [PP17] Karol Palka and Tomasz Pełka, *Classification of planar rational cuspidal curves I. \mathbb{C}^{**} -fibrations*, Proc. Lond. Math. Soc. (3) **115** (2017), no. 3, 638–692.
- [Rus80] Peter Russell, *Hamburger-Noether expansions and approximate roots of polynomials*, Manuscripta Math. **31** (1980), no. 1-3, 25–95.
- [tD92] Tammo tom Dieck, *Optimal rational curves and homotopy planes*, Bol. Soc. Mat. Mexicana (2) **37** (1992), no. 1-2, 115–138, Papers in honor of José Adem (Spanish).
- [tD95] ———, *A letter to H. Flenner*, 1995.
- [Ton00a] Keita Tono, *Defining equations of certain rational cuspidal curves. I*, Manuscripta Math. **103** (2000), no. 1, 47–62.
- [Ton00b] ———, *Defining equations of certain rational cuspidal plane curves*, Doctoral thesis, Saitama University, 2000.
- [Ton12a] ———, *On a new class of rational cuspidal plane curves with two cusps*, [arXiv:1205.1248](https://arxiv.org/abs/1205.1248), 2012.
- [Ton12b] ———, *On Orevkov’s rational cuspidal plane curves*, J. Math. Soc. Japan **64** (2012), no. 2, 365–385.
- [Ton14] ———, *On the self-intersection number of the nonsingular models of rational cuspidal plane curves*, [arXiv:1408.0190](https://arxiv.org/abs/1408.0190), 2014.
- [Tsu81] Shuichiro Tsunoda, *The complements of projective plane curves*, vol. 446, RIMS Kokyuroku, 1981, pp. 48–56.
- [Wak78] Isao Wakabayashi, *On the logarithmic Kodaira dimension of the complement of a curve in \mathbb{P}^2* , Proc. Japan Acad. Ser. A Math. Sci. **54** (1978), no. 6, 157–162.
- [Zai95] Mikhail Zaidenberg, Open problems on open algebraic varieties (R. Gurjar, S. Kaliman, N. Mohan Kumar, M. Miyanishi, P. Russell, F. Sakai, D. Wright, and M. Zaidenberg, eds.), Montreal, 1995, [arXiv:alg-geom/9506006](https://arxiv.org/abs/alg-geom/9506006).

INSTITUTE OF MATHEMATICS, POLISH ACADEMY OF SCIENCES, UL. ŚNIADECKICH 8, 00-656 WARSAW, POLAND

E-mail address: palka@impan.pl

E-mail address: tpełka@impan.pl