



## Full length article

# Anaerobic digestion of biowaste in Indian municipalities: Effects on energy, fertilizers, water and the local environment

T. Gross<sup>a,c,\*</sup>, L. Breitenmoser<sup>a</sup>, S. Kumar<sup>b</sup>, A. Ehrensperger<sup>c</sup>, T. Wintgens<sup>a,d</sup>, C. Hugli<sup>a</sup>

<sup>a</sup> Institute for Ecopreneurship, School of Life Sciences, University of Applied Sciences and Arts Northwestern Switzerland (FHNW), 4132 Muttenz, Switzerland

<sup>b</sup> Council of Scientific and Industrial Research-National Environmental Engineering and Research Institute (CSIR-NEERI), Nehru Marg, Nagpur 440 020, India

<sup>c</sup> Centre for Development and Environment, University of Berne, 3012 Berne, Switzerland

<sup>d</sup> Institute of Environmental Engineering, RWTH Aachen University, 52056 Aachen, Germany



## ARTICLE INFO

## Keywords:

Biowaste management  
Environmental pollution  
Material flow analysis (MFA)  
Renewable energies  
Sustainable agriculture

## ABSTRACT

Anaerobic digestion (AD) of biowaste seems promising to provide renewable energy (biogas) and organic fertilizers (digestate) and mitigate environmental pollution in India. Intersectoral analyses of biowaste management in municipalities are needed to reveal benefits and trade-offs of AD at the implementation-level. Therefore, we applied material flow analyses (MFAs) to quantify effects of potential AD treatment of biowaste on energy and fertilizer supply, water consumption and environmental pollution in two villages, two towns and two cities in Maharashtra. Results show that in villages AD of available manure and crop residues can cover over half of the energy consumption for cooking (EC) and reduce firewood dependency. In towns and cities, AD of municipal biowaste is more relevant for organic fertilizer supply and pollution control because digestate can provide up to several times the nutrient requirements for crop production, but can harm ecosystems when discharged to the environment. Hence, in addition to energy from municipal biowaste - which can supply 4-6% of EC - digestate valorisation seems vital but requires appropriate post-treatment, quality control and trust building with farmers. To minimize trade-offs, water-saving options should be considered because 2-20% of current groundwater abstraction in municipalities is required to treat all available biowaste with 'wet' AD systems compared to <3% with 'dry' AD systems. We conclude that biowaste management with AD requires contextualized solutions in the setting of energy, fertilizers and water at the implementation-level to conceive valorization strategies for all AD products, reduce environmental pollution and minimize trade-offs with water resources.

## 1. Introduction

In many low- and middle-income countries, a high content of biodegradable matter in municipal solid waste (MSW), small collection rates, lacking treatment and unsafe disposal cause environmental, public health and socio-economic burdens (ISWA and UNEP, 2015; Lohri et al., 2017). Likewise, the burning of crop residues is an unresolved problem that pollutes the air in agricultural regions (Gadde et al., 2009; Sfez et al., 2017). India is characteristic for these challenges as 80% of the 0.3 billion tons MSW per year ( $t\ yr^{-1}$ ) goes to poorly developed dumpsites and burning of crop residues is common (CPCB, 2018; World Bank, 2018; Hiloidhari et al., 2014).

Biodegradable solid waste, hereafter called biowaste, is a promising starting point for more sustainable solid waste management because

available technologies such as composting and anaerobic digestion (AD) can reduce impacts on the environment and public health and recover useful products (Lohri et al., 2017). Indian solid waste laws and guidelines assign municipalities the responsibility for waste management, recommend a waste hierarchy prioritizing waste reduction over treatment and landfilling, require biowaste source-segregation and promote biological treatment for biowaste (CPHEEO, 2016; MoEFCC, 2016). Among possible treatment technologies, AD has gained attention and is supported by government programmes because its products – biogas and digestate – can contribute to the supply of renewable energy and organic fertilizers (Rao et al., 2010; Breitenmoser et al., 2019).

Waste-to-energy has been a major driver for AD in India to diversify and improve energy supply in rural areas and to foster renewable energies (MoP, 2017; Breitenmoser et al., 2019). The theoretical energy

\* Corresponding author at: Institute for Ecopreneurship, School of Life Sciences, University of Applied Sciences and Arts Northwestern Switzerland (FHNW), 4132 Muttenz, Switzerland.

E-mail address: [thomas.gross@fhnw.ch](mailto:thomas.gross@fhnw.ch) (T. Gross).

<https://doi.org/10.1016/j.resconrec.2021.105569>

Received 9 October 2020; Received in revised form 9 January 2021; Accepted 15 March 2021

Available online 4 April 2021

0921-3449/© 2021 The Authors. Published by Elsevier B.V. This is an open access article under the CC BY license (<http://creativecommons.org/licenses/by/4.0/>).

**Table 1**

Indian government programmes supporting anaerobic digestion of biowaste (adapted from Breitenmoser et al. 2019); Mun = municipal biowaste, Man = manure, Crop = crop residues, and Ind = industrial biowaste.

Programme	Biowaste type	Energy type	Scale	References
New National Biogas and Organic Manure Programme (NNBOMP) <sup>a</sup>	Man, Crop	Cooking, lighting and small-scale electric/thermal energy conversion	Individual and multiple households, 1-25 m <sup>3</sup> biogas per day (ca. 10-200 t biowaste yr <sup>-1</sup> )	MNRE (2014a, 2019a)
Biogas based Power Generation and Thermal application Programme (BPGTP)	Man, Crop, Mun, Ind	Electricity and/or thermal energy (heating, cooling, cooking)	Decentral, 3-250 kW (ca. 200-16,000 t biowaste yr <sup>-1</sup> )	MNRE (2018b)
Programme on energy from urban, industrial and agricultural waste/residues (WtE)	Man, Crop, Mun, Ind	Biogas for bio-CNG or electricity	No minimum or maximum, except that manure-based systems up to 250 kW are not supported	MNRE (2018a)
Research, Development and Demonstration Programme (RD&D)	Man, Crop, Mun, Ind	Various	Decentral or central, no specific scale	MNRE (2019b)

<sup>a</sup> Formerly National Biogas and Manure Management Programme (NBMMP).

potential of AD has been estimated at 374 PJ (10<sup>15</sup> joule) yr<sup>-1</sup> for cattle and buffalo manure, 361 PJ yr<sup>-1</sup> for crop residues, 73 PJ yr<sup>-1</sup> for municipal biowaste and 20 PJ yr<sup>-1</sup> for industrial biowaste, in total about 2-3% of the total energy consumption in India in 2013 (Rao et al., 2010; MOSPI, 2017; Breitenmoser et al., 2019). Additionally, ca. 3 PJ yr<sup>-1</sup> could be generated from AD of sludge from wastewater treatment (Singh et al., 2020). The Indian government has supported AD primarily for renewable energy supply (Table 1) which reflects difficulties to supply sufficient, safe and sustainable energy in India today and in the future (Government of India [GoI] 2015). About half of rural households have no access to electricity and two-thirds depend on burning firewood and crop residues for cooking, which causes indoor air pollution, deforestation and high collection efforts (CEA, 2017; Singh et al., 2014; Lewis et al., 2017). Urban households have a more reliable and safer access to energy, but it has considerable environmental burdens because fossil fuels dominate for electricity generation and cooking, for which liquefied petroleum gas (LPG) is used in 65% of households (GoI, 2011c; CEA, 2017; Singh et al., 2014).

Digestate as fertilizer and possible trade-offs from water and energy requirements of AD have received less attention in India. Digestate is used in various countries to substitute chemical fertilizers partially (Möller and Müller, 2012; Sogn et al., 2018). In India, digestate from household-scale AD of manure is generally used as fertilizer; however, digestate from municipal biowaste is often discharged into sewers, water bodies or onto land, posing environmental and human health risks (Vögeli et al., 2014; CPHEEO, 2016). Empirical data on nutrient use efficiency, crop yield and soil health after digestate application, e.g. due to contaminations with heavy metals or organic pollutants, are limited in India and studies have focused on agricultural biowaste (e.g. Katakai et al., 2017). Also water required to dilute or moisturize biowaste during AD deserves more attention because its supply is very limited in many regions (UNICEF et al., 2013). Although water-saving 'dry' (high-solids) AD may bring advantages over 'wet' (low-solids) AD in regions with water scarcity and/or large amounts of dry crop residues, wet AD is still much more common in India (Kothari et al., 2014; Surendra et al., 2014). Lastly, it has to be considered that required energy inputs can range from 10% to 65% of primary energy outputs depending on technology, biowaste, climate and transport distances (Pöschl et al., 2010).

AD of biowaste is promising for the environment and public health. Diverting biowaste from disposal toward treatment and use can counteract climate change, because globally 90% of greenhouse gas (GHG) emissions of the waste sector is methane from landfills (Bogner et al., 2008; Mertaenat 2019). Life cycle analyses (LCAs) have shown that AD of biowaste can save resources and reduce climate change and ecotoxicological impacts from waste, energy and agricultural sectors when fossil fuels and chemical fertilizers are substituted (e.g. Evangelisti et al., 2014; Turner et al., 2016; Silva dos Santos et al., 2018). These multiple purposes of AD provide environmental advantages and additional potential revenue sources compared to landfilling and composting (Tiwary et al., 2015; Lin et al., 2018). Although in countries with unsafe solid waste practices local impacts of biowaste on ecosystems and public

health may be more relevant for implementation than global impacts, to our knowledge no studies have estimated the potential of AD to reduce local pollution in Indian municipalities.

Hence, intersectoral implementation-level analyses and approaches addressing effects of biowaste management on energy and fertilizer supply, water demand and local pollution would be important for policy makers, investors and planners to delimit the market potential for AD products, appraise potential barriers, avoid overoptimistic estimates of biowaste quantity and quality and process inputs (particularly water), and gain support for remuneration of pollution control. Therefore, we present and apply an approach based on material flow analysis (MFA) of biowaste management in municipalities to quantify the potential of AD to substitute conventional energy and fertilizer sources, to determine trade-offs from water and energy inputs, and to estimate the potential to reduce biowaste related emissions to the local environment. We apply the approach in six municipalities in Maharashtra along a gradient of population density from 700 to 18,000 inhabitants per km<sup>2</sup> and discuss results in the context of Indian laws and programmes promoting AD of biowaste.

## 2. Material and methods

### 2.1. Municipalities: Villages, towns and cities

We selected six municipalities in rural to urban settings along a gradient of population density: two villages, two towns and two cities in the state of Maharashtra, India (Fig. 1). The selected municipalities represent characteristic biowaste management in the project region based on previous studies (Kumar et al., 2017; MMRDA and NEERI, 2011) and refer to municipality types of the Indian national census (villages, 'class I towns' and 'million plus urban agglomerations/cities'; GoI, 2011a; GoI, 2011b). The villages Deolapar and Pachgaon (hereafter called V1 and V2) have a high agricultural land cover with many households engaged in small-scale farming. The towns Badlapur and Amarnath (T1 and T2) have urban centres surrounded by vast agricultural areas. The cities Nagpur and Thane (C1 and C2) are administrative urban centres. We extrapolated inhabitant and household numbers to 2017 from national census data of 2001 and 2011 (GoI, 2001 and 2011d, Fig. 1). V1, V2, and C1 are in central India with hot summers and dry conditions except during monsoon (annual rainfall 1,000-1,200 mm), while T1, T2 and C2 have warm summers and a humid climate (annual rainfall 1,900-2,600 mm, CGWB, 2009, 2013).

### 2.2. Approach

MFAs were used to capture major processes and mass flows of municipal biowaste management covering municipal biowaste (household, commercial and market biowaste), cattle and buffalo manure and crop residues (Fig. 2A). The following steps build the main workflow:

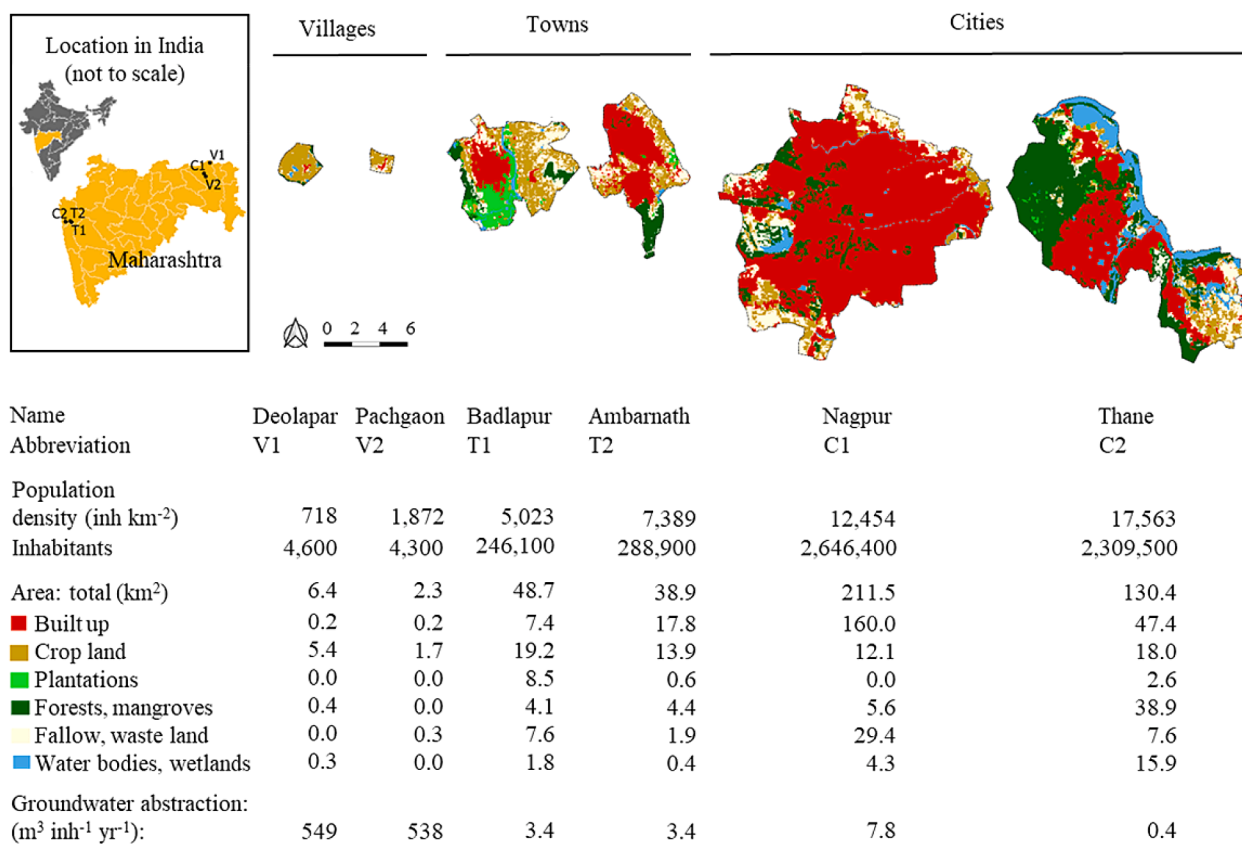

Fig. 1. Maps and background information of municipalities in the baseline (2017): villages (V1 and V2), towns (T1 and T2) and cities (C1 and C2), own visualization based on NRSC and NESAC (2012), CGWB (2009, 2013) and Government of India (2001 and 2011b); inh = inhabitants, yr = year.

- 1) Modelling of baseline MFAs of biowaste management in 2017 (Section 2.3);
- 2) modifying baseline MFAs to represent possible biowaste management systems with AD of 'available' biowaste, i.e. biowaste for which no resource competition is expected and which can be collected with reasonable effort (Section 2.4);
- 3) calculating the potential of AD products to substitute conventional cooking fuels or electricity for household appliances and chemical fertilizers in municipalities (Section 2.5);
- 4) quantifying water and energy inputs for biowaste management with AD (Section 2.6);
- 5) quantifying the potential of AD to reduce biowaste emissions to the local environment (Section 2.7); and
- 6) identifying uncertainties to highlight limitations and research needs (Section 2.8).

Data on biowaste properties and biochemical methane (CH<sub>4</sub>) potential (BMP) - a measure of the biogas potential of biowaste - had been gathered in all six municipalities in 2017 (Breitenmoser et al., 2018). Biowaste content (% of wet or fresh weight), total solids (TS, % of wet weight), volatile solids (% of TS) and BMP at mesophilic 37°C (normal litres CH<sub>4</sub> per kg VS) were determined in triplicate for solid waste sampled at municipal (residential and market) and agricultural waste collection points during pre-monsoon, monsoon and post-monsoon (municipal biowaste: 93 samples, crop residues: 15 samples; Breitenmoser et al., 2018). Table 2 shows ranges of season-length adjusted means of BMP values in kg CH<sub>4</sub> per kg TS (kg<sub>CH4</sub> kg<sub>TS</sub><sup>-1</sup>) from these samples. For manure, which was not sampled, literature values from India were used (Ravindranath et al., 2005; Krishania et al., 2013).

### 2.3. Baseline MFAs of biowaste management in municipalities

Geographic system boundaries were administrative municipality borders. MFA import flows included municipal biowaste, manure and crop residue generation; export flows were agricultural products ready for use (i.e. crop residues fed to animals, compost and digestate), and emissions to land/water and air. Emissions from biogas conversion to energy (process 'energy conversion', Fig. 2A) as well as emissions until the gate of the AD plant were within the system boundaries (flows 'to land/water' and 'to air' from processes 'AD, decentral' and 'AD, central', Fig. 2A). Biowaste mass flows were expressed as TS per inhabitant and year (kg<sub>TS</sub> inh<sup>-1</sup> yr<sup>-1</sup>), gases and smoke as kg inh<sup>-1</sup> yr<sup>-1</sup>. MFAs were modelled in STAN (version 2.5, e.g. Cencic and Rechberger, 2008; Klinglmair et al., 2017). R (version 3.4.0, R Core Team 2017) and QGIS (version 3.8, Quantum GIS Development Team, 2019) were used for data pre- and post-processing.

MFA processes and flows were derived from municipality-level reports, a MSW study in Maharashtra (MMRDA and NEERI, 2011) and interviews with municipal officials. Stakeholder workshops and/or interviews were conducted in all six municipalities during 2017 and 2018 to improve draft MFAs, discuss options for AD and for data gap filling. A single MFA setup (Fig. 2A) was used for all municipalities with municipality-specific import flow values and transfer-coefficients (fractioning of process input flows between output flows).

The MFA import flows total municipal biowaste, manure and crop residue generation (TB<sub>Municipal</sub>, TB<sub>Manure</sub> and TB<sub>Crop residues</sub>, kg<sub>TS</sub> inh<sup>-1</sup> yr<sup>-1</sup>) were calculated for each municipality with Formulae 1–3:

$$TB_{Municipal} = \sum_{t=1}^3 \frac{M_t \times B_t \times TS_t}{inh} \quad (1)$$

where M<sub>t</sub> is the wet weight of MSW type t (1 = household, 2 =

A) MFA setup applied to all municipalities

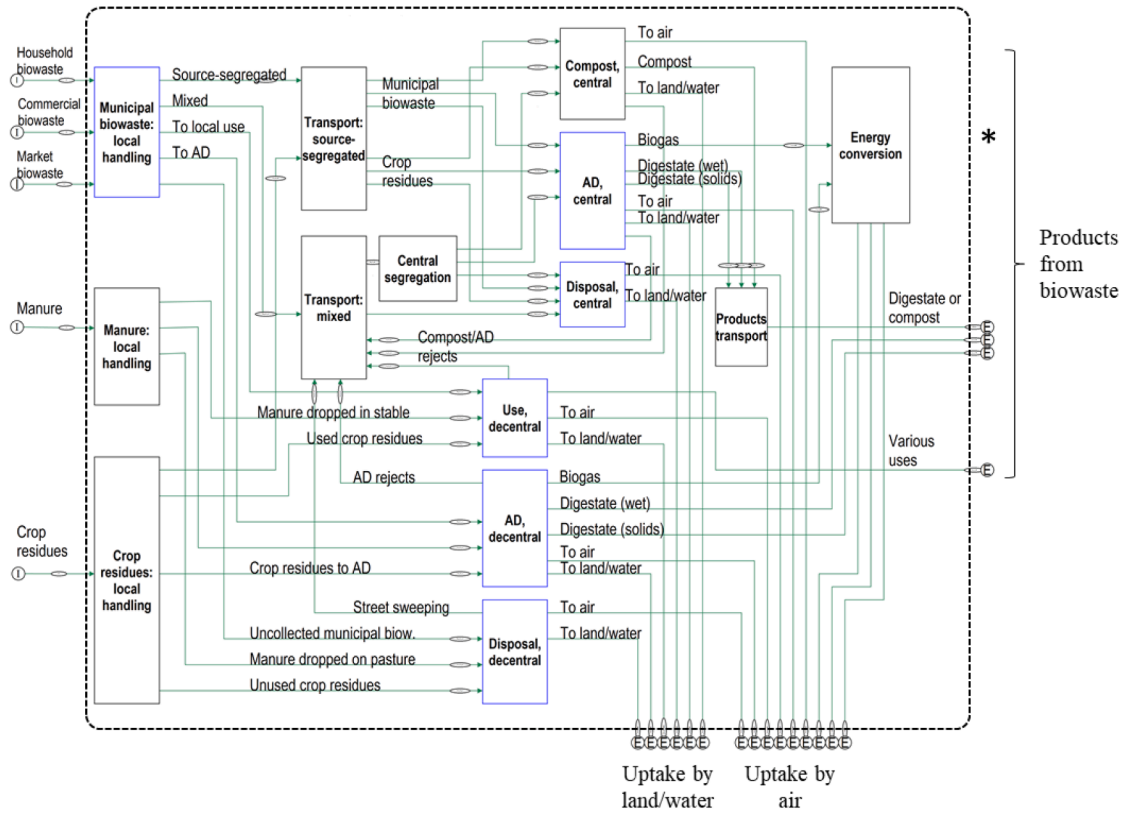

B) Biowaste management in V1 (baseline)

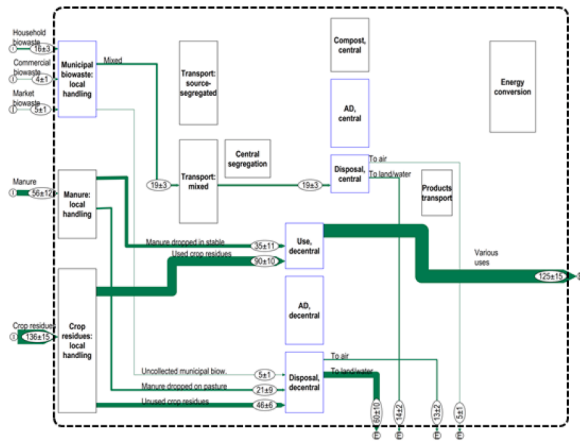

C) Biowaste management in C2 (baseline)

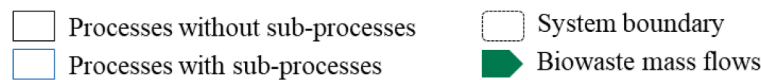
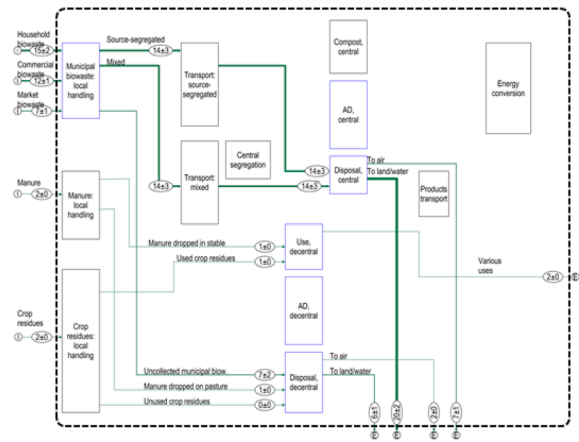

Fig. 2. MFA setup to analyse biowaste management in Indian municipalities (A) and example results in village V1 (B, lowest population density) and city C2 (C, highest population density) in the baseline (2017), sub-processes and results of other municipalities are presented in Fig. A7; values in kg<sub>TS</sub> (solids and liquids) or kg (smoke and gases) per inhabitant and year ± s.d.; \* energy has no mass, hence no mass flow is drawn.

commercial and 3 = market waste) generated per year (kg yr<sup>-1</sup>); B<sub>i</sub> is the municipality-specific biowaste fraction in M<sub>i</sub> (% wet weight, Table 2); TS<sub>i</sub> is the municipality-specific TS content (kg<sub>TS</sub> kg<sup>-1</sup>, Table 2) and inh is the number of inhabitants in 2017 (Fig. 1). Amounts of generated and collected MSW were gathered from municipality-level reports; when only the collected MSW was provided there, the uncollected fraction was estimated by local municipal officials (Table A1).

$$TB_{\text{Manure}} = \sum_{l=1}^2 \frac{H \times N_l \times M_l \times TS_l}{\text{inh}} \quad (2)$$

where H is the number of households in the municipality; N<sub>l</sub> is the district-level average number of livestock l (1 = cattle and 2 = buffalo) per rural (villages) or urban (towns and cities) household (DAHD 2012);

**Table 2**

Biowaste properties of municipal biowaste (HH = household, CM = commercial and MA = fruit and vegetable markets), manure and crop residues; detailed data for each municipality in Tables A1-A3.

Biowaste type	Percentage of mixed waste <sup>a</sup> (% wet weight)	TS <sup>a</sup> (kg <sub>TS</sub> kg <sup>-1</sup> )	VS <sup>a</sup> (kg <sub>VS</sub> kg <sub>TS</sub> <sup>-1</sup> )	BMP <sup>a</sup> (kg CH <sub>4</sub> kg <sub>VS</sub> <sup>-1</sup> )	Plant nutrients in digestate <sup>b</sup> (g kg <sub>TS</sub> <sup>-1</sup> digestate)		
					NH <sub>4</sub> <sup>+</sup> -N	P	K
Municipal							
HH, CM	75-80	25-36	73-88	0.1-0.2	29	7	32
MA	75-98	21-36	75-89	0.1-0.2	29	7	32
Manure	100	20	80	0.2	29	9	51
Crop residues	85-95	71-77	65-91	0.1	9	2	20

<sup>a</sup> Ranges of season-length adjusted mean values presented by Breitenmoser et al. (2018) except for manure which is based on Ravindranath et al. (2005) and Krishania et al. (2013)

<sup>b</sup> Based on Nkoa (2014), Kern et al. (2010) and Möller (2016).

M<sub>l</sub> is the amount of manure generated per livestock and year (cattle: 3,700 kg yr<sup>-1</sup>; buffalo: 5,500 kg yr<sup>-1</sup>) and TS<sub>l</sub> its TS content (0.2 kg<sub>TS</sub> kg<sup>-1</sup> for both livestock types, Ravindranath et al., 2005; Krishania et al., 2013).

$$TB_{\text{Crop residues}} = \sum_{c=1}^{10} \frac{A \times F_c \times Y_c \times R_c \times TS_c}{inh} \quad (3)$$

where A is the crop area (hectares, ha) measured in digital land cover maps (NRSC and NESAC, 2012); F<sub>c</sub> is the district-level fraction (0.0-1.0) of land area covered by the ten most common crop types c (ICRISAT, 2014, Table A3); Y<sub>c</sub> is the district-level main crop yield of c (kg ha<sup>-1</sup>, ICRISAT, 2014); R<sub>c</sub> is the crop-specific residue fraction per yield (kg kg<sup>-1</sup>, Hiloidhari et al., 2014); and TS<sub>c</sub> the municipality-specific TS content in crop residues (kg<sub>TS</sub> kg<sup>-1</sup>, Table 2).

#### 2.4. MFAs with possible AD of available biowaste

After establishing baseline MFAs, MFAs of possible alternative biowaste management systems with AD were established by routing 'available biowaste' through AD processes (Fig. 2A). Only a part of total biowaste (Formulae 1–3) was considered available (AB<sub>Municipal</sub>, AB<sub>Manure</sub> and AB<sub>Crop residues</sub>, kg<sub>TS</sub> inh<sup>-1</sup> yr<sup>-1</sup>), from which biowaste which served other purposes such as animal feeding (Fig. 2A: export flow 'various uses') and biowaste considered impractical to collect and/or segregate was excluded. Because 'impractical' cannot be precisely defined, for sensitivity analysis (Section 2.8) a standard and lower estimate was defined in Formulae 4–6:

$$AB_{\text{Municipal}} = TB_{\text{Municipal}} \times C \times E \quad (4)$$

where C is the municipality-specific collected fraction of TB<sub>Municipal</sub> (Table A1) and E (fraction) the estimated practically achievable source-segregation. Uncollected biowaste is often informally used, and was considered unavailable for AD. The standard estimate of E was 0.5 based on international examples (e.g. about 30% and 55% of biowaste in Europe and Switzerland, respectively, Möller, 2016; FOEN, 2016) and the lower estimate was 0.25.

$$AB_{\text{Manure}} = TB_{\text{Manure}} \times S_1 \quad (5)$$

where S<sub>1</sub> is the assumed fraction of TB<sub>Manure</sub> (Formula 2) dropped in stables by livestock l with standard estimates of S<sub>1</sub>=0.6 for cattle and S<sub>2</sub>=0.8 for buffalo (Ravindranath et al., 2005) and lower estimates of S<sub>1</sub>=0.3 and S<sub>2</sub>=0.4. Only manure dropped in stables was considered available, because manure dropped outside is difficult to collect and its collection could disturb nutrient cycling on pastures.

$$AB_{\text{Crop residues}} = TB_{\text{Crop residues}} \times U_c \times F \quad (6)$$

where U<sub>c</sub> is the crop-specific fraction of TB<sub>Crop residues</sub> (Formula 3) which

was unused based on Maharashtra-level data (Hiloidhari et al., 2014). To account for spatial distribution making collection of all crop residues unlikely, F defines the practically collectable fraction with 0.5 as standard and 0.25 as lower estimate.

Possible alternative biowaste management systems with AD were defined with reference to Indian governmental programmes supporting AD (Table 1) and represented in MFAs as processes 'AD, decentral' and 'AD, central' (Fig. 2A; Appendix section 2):

- For AB<sub>Municipal</sub> we assumed source-segregated biowaste collection required by Indian laws and treatment in mid- to large scale central AD plants (capacity ca. 10,000 t yr<sup>-1</sup> wet weight) supported by the 'Programme on energy from urban, industrial and agricultural waste/residues' (MNRE, 2018a).
- For AB<sub>Manure</sub> we assumed treatment in household-scale low-tech decentral AD plants (capacity ca. 10 t yr<sup>-1</sup> wet weight), use of biogas for cooking and application of digestate on farmland supported by the 'New National Biogas and Organic Manure Management Programme' (MNRE, 2019a).
- For AB<sub>Crop residues</sub> we assumed local collection and treatment in medium-scale decentral AD (capacity ca. 2,000 t yr<sup>-1</sup> wet weight) nearby agricultural areas supported by the 'Biogas based Power Generation and Thermal application Programme' (MNRE, 2018b).

Biogas post-treatment from medium- to large-scale AD (municipal biowaste and crop residues) was modelled as purification and bottling to biogenic compressed natural gas ('bio-CNG') into LPG-like cylinders as cooking fuel. While bottling to CNG cylinders as motor fuel is a standard technology (e.g. Pöschl et al., 2010), only pre-commercial trials have been reported for bio-CNG for cooking which would require more frequent refills or larger cylinder sizes due to a lower energy density per volume bio-CNG compared to LPG (Kadam and Panwar, 2017; Twinomunuji et al., 2020). Research and/or demonstration plants involving bottling of biogas are supported by the 'Research, Development & Demonstration' programme (MNRE, 2019b, Table 1). For comparison, also electricity generation via gas-powered electricity generators was calculated for medium- to large-scale AD, which is more common for practical reasons, but can only convert ca. 33% of the energy to electricity (Pöschl et al., 2010); heat generated in the process is difficult to utilize in a hot climate. For household-scale AD of manure direct use for cooking without post-treatment was assumed.

Digestate from household-scale AD of manure requires no post-treatment and was assumed to be used as organic fertilizer. For digestate from mid- and large-scale AD solid/liquid separation was assumed which is commonly done via screw press separators and decanter centrifuges (Al Seadi et al., 2013).

Methane in biogas from AD (G<sub>w</sub>, kg inh<sup>-1</sup> yr<sup>-1</sup>) and amounts of digestate (D<sub>w</sub>, kg<sub>TS</sub> inh<sup>-1</sup> yr<sup>-1</sup>), were calculated with Formulae 7 and 8, respectively:

$$G_w = AB_w \times VS_w \times BMP_w \quad (7)$$

$$D_w = AB_w - \frac{G_w}{0.55} \quad (8)$$

where  $AB_w$  is available biowaste  $w$  ( $AB_{\text{Municipal}}$ ,  $AB_{\text{Manure}}$  and  $AB_{\text{Crop}}$  residues);  $VS_w$  ( $\text{kg VS kg}_{\text{TS}}^{-1}$ ) and  $BMP_w$  ( $\text{kg CH}_4 \text{ kg}_{\text{TS}}^{-1}$ ) are the municipality-specific VS contents and BMP of  $w$  (Table 2); and  $\frac{G_w}{0.55}$  is the produced biogas assuming 0.55  $\text{kg CH}_4$  per  $\text{kg}$  biogas (Wellinger et al., 2013).

Biogas losses from leaks and during operation of AD ( $\text{kg inh}^{-1} \text{ yr}^{-1}$ ) were calculated as:

$$L_w = \frac{G_w}{0.55} \times l_w \quad (9)$$

where  $\frac{G_w}{0.55}$  is the total biogas produced ( $\text{kg inh}^{-1} \text{ yr}^{-1}$ , Formula 8) per biowaste type  $w$ , and  $l_w$  is the average loss of 10% of biogas produced in household-scale AD according to a study in India (Bruun et al., 2014) and 5% of biogas produced in mid- to large-scale AD (IPCC, 2006).

### 2.5. Quantification of energy and fertilizer products

The energy potential of available biowaste was quantified as useful energy for cooking – i.e. the energy which contributes to cooking meals – or electric energy per biowaste type  $w$  ( $EP_w$ ,  $\text{MJ inh}^{-1} \text{ yr}^{-1}$ ) in each municipality as:

$$EP_w = (G_w - L_w \times 0.55) \times \text{LHV} \times \eta_p \quad (10)$$

where  $G_w$  is methane in biogas (Formula 7);  $L_w \times 0.55$  is methane in biogas lost through leaks (Formula 9); LHV is the lower heating value of methane ( $55 \text{ MJ kg}^{-1} \text{ CH}_4$ ; Wellinger et al., 2013); and  $\eta_p$  the efficiency to convert energy in biogas to its intended use  $p$  (cooking in household-scale AD: 55%, cooking with bio-CNG: 57%; conversion to electricity: 33%; Singh et al., 2014; Pöschl et al., 2010).

The consumption of useful energy for cooking in households was quantified per fuel  $i$  ( $EC_i$ ,  $\text{MJ inh}^{-1} \text{ yr}^{-1}$ ) in each municipality as:

$$EC_i = H_i \times C_i \times \text{LHV}_i \times \eta_i \quad (11)$$

where  $H_i$  is the fraction of households that used mainly fuel  $i$  (crop residues or firewood, kerosene, LPG) in 2017 (GoI, 2011e,f);  $C_i$  is the average amount of  $i$  used per inhabitant and year ( $\text{kg inh}^{-1} \text{ yr}^{-1}$ , NSSO, 2014); and  $\text{LHV}_i$  is the energy content ( $\text{MJ kg}^{-1}$ ) and  $\eta_i$  the conversion efficiency to intended use for cooking (%) of  $i$  (Table 3). Electricity consumption for household appliances was estimated as  $380 \text{ MJ inh}^{-1} \text{ yr}^{-1}$  in villages and  $1,100 \text{ MJ inh}^{-1} \text{ yr}^{-1}$  in towns and cities (NSSO, 2014).

The fertilizer potential of AD of available biowaste was estimated per plant nutrient  $f$  (N in ammonium:  $\text{NH}_4^+\text{-N}$ , phosphorus: P and potash: K) in digestate of biowaste type  $w$  ( $FP_{f,w}$ ,  $\text{kg inh}^{-1} \text{ yr}^{-1}$ ) in each municipality as:

$$FP_{f,w} = D_w \times c_{f,w} \quad (12)$$

where  $c_{f,w}$  is the concentration of plant nutrient  $f$  in fresh digestate (in  $\text{kg}_{\text{TS}}^{-1}$ , Table 2) of biowaste type  $w$  ( $D_w$ , Formula 8). P and K species in digestate can be considered fully plant available over time and were

**Table 3**

Assumptions for cooking fuels (NSSO, 2014, Singh et al. 2014), LHV = lower heating value,  $\eta$  = conversion efficiency to cooking energy.

Cooking fuel	Consumption ( $\text{kg inh}^{-1} \text{ yr}^{-1}$ )	LHV ( $\text{MJ kg}^{-1}$ )	$\eta$ (%)
Crop residues	208	11.0	11
Firewood	208	14.0	15
Kerosene	3.7	45.9	47
LPG (rural)	7.3	49.4	57
LPG (urban)	25.6	49.4	57

directly compared to P and K in chemical fertilizers;  $\text{NH}_4^+\text{-N}$  was compared to N in chemical fertilizers as this has been suggested as indicator for the overall N-fertilizer value of digestates (Möller and Müller, 2012; Sogn et al., 2018).

The consumption of chemical fertilizers for crop production ( $FC_f$   $\text{kg inh}^{-1} \text{ yr}^{-1}$ ) was estimated in each municipality as:

$$FC_f = \sum_{c=1}^{10} \frac{A \times F_c \times R_{f,c}}{\text{inh}} \quad (13)$$

where  $A$  is the crop area in the municipality (ha);  $F_c$  is the district-level fraction of crop area used for crop  $c$ ; and  $R_{f,c}$  is the application rate of the chemical fertilizer  $f$  (N, P or K) for  $c$  ( $\text{kg ha}^{-1}$ ) based on FAO (2006, crop-specific values, Table A4).

### 2.6. Quantification of energy and water inputs

Energy inputs were estimated as energy consumed for transportation and to operate machinery in AD (energy for construction was not included). For biowaste collection and transportation and digestate transportation to fields we assumed  $0.049 \text{ MJ kg}_{\text{TS}}^{-1}$  per km distance (Pöschl et al., 2010). We estimated biowaste collection and transportation distances as 5 km in villages, 10 km in towns and 15 km in cities, representing the maximum direct line between municipality borders, and again the same distance for digestate transportation to fields. We assumed  $0.54 \text{ MJ kg}_{\text{TS}}^{-1}$  for pre-treatment of biowaste, 3% of energy contained in produced biogas ( $G_w$ , Formula 7) for electric equipment in AD operation and  $2.0 \text{ MJ per m}^3$  produced biogas for upgrading and compression to bio-CNG (Pöschl et al., 2010). We did not include heating for mesophilic AD due to the hot climate. Low-tech household-scale AD of manure requires no energy input except manual labour.

Water inputs ( $W$ ,  $\text{kg inh}^{-1} \text{ yr}^{-1}$ ) were estimated as:

$$W = \frac{AB_w \times TS_w}{TS_{\text{Target}}} - AB_w \quad (14)$$

where  $TS_w$  is TS content in available biowaste  $w$  (Table 2) treated in AD ( $AB_w$ , Formulae 4–6) and  $TS_{\text{Target}}$  is the target TS in the digester ( $\text{kg}_{\text{TS}} \text{ kg}^{-1}$  digester content). For  $W < 0$  we assumed no water input; in practice, mixing with dry biowaste may be done (Vandevivere et al., 2003).  $TS_{\text{Target}}$  was 12% for wet AD. For comparison, water consumption in water-saving dry AD was estimated with a  $TS_{\text{Target}}$  of 30% based on available batch and continuous systems (20–50%, Vandevivere et al., 2003; Rocamora et al., 2020). There is a lack of data on water inputs in full-scale AD and estimates with Formula 14 are at the upper range of reference values (e.g.  $1 \text{ m}^3$  water per ton municipal biowaste in wet AD, Lissens et al., 2001).

To quantify potential additional pressures on water resources, water inputs for AD in each municipality were compared to current ground-water abstraction (Fig. 1, CGWB, 2009, 2013).

### 2.7. Quantification of emissions to the local environment

Amounts of biowaste and derivatives (e.g. ashes, smoke) released to the local environment were quantified as  $\text{kg}_{\text{TS}} \text{ inh}^{-1} \text{ yr}^{-1}$  taken up by land/water or  $\text{kg inh}^{-1} \text{ yr}^{-1}$  taken up by air (Fig. 2A). No differentiation was made between uptake by land or water since this requires information on exact locations (e.g. vicinity of a dumpsite to a water body) which was beyond the scope of this study.

Uptake by land/water included biowaste and derivatives remaining on central and decentral dumpsites or agricultural fields (crop residues only) after possible treatment. We assumed that 60% of disposed municipal biowaste was openly burned and that ca. 60% of TS in burnt biowaste become ash and 40% smoke (IPCC, 2006; Kumari et al., 2017). Uptake by air comprised smoke from open burning, gaseous emissions during digestate storage, leaks (Formula 9) and burned biogas.

Longer-term emissions from biowaste decomposition were not estimated, but our data can serve as inventory for future studies.

### 2.8. Uncertainty and sensitivity analysis

An uncertainty analysis was performed to describe the quality of data and highlight knowledge gaps. Uncertainties of input data were scored using the data quality indicators reliability, completeness, and temporal, geographical and further correlations (1 = best to 4 = worst, Tables A9-A10). These scores were converted into symmetrical coefficients of variation (CVs, %) around the values based on an approach described by Laner et al. (2016). CVs were entered in STAN and aggregated using Gaussian error propagation assuming normal distribution (Laner et al., 2016; Zoboli et al., 2016).

The sensitivity of results to different estimates of biowaste availability was assessed Formulae 4-6. Standard estimates reflect a technological potential based on international examples or, where no data are available, estimates by the authors. Lower estimates are 50% of standard estimates while maximum estimates are the theoretical potential from total biowaste generation.

## 3. Results

### 3.1. Biowaste management in 2017

Total biowaste generation Formulae 1-3 was 13-35 kg<sub>TS</sub> inh<sup>-1</sup> yr<sup>-1</sup> municipal biowaste, 2-98 kg<sub>TS</sub> inh<sup>-1</sup> yr<sup>-1</sup> manure and 1-136 kg<sub>TS</sub> inh<sup>-1</sup> yr<sup>-1</sup> crop residues in the six municipalities in 2017 (Fig. 3A-F: total height of bars). Expectedly, agricultural biowaste generation (manure plus crop residues) declined with increasing population density from village V1 (192 kg<sub>TS</sub> inh<sup>-1</sup> yr<sup>-1</sup>) to C2 (3 kg<sub>TS</sub> inh<sup>-1</sup> yr<sup>-1</sup>), whereas municipal biowaste generation was not correlated with population

density.

MFAs of biowaste management show limited treatment and valorisation of collected municipal biowaste and extensive local use of manure and crop residues (Fig. 2B-C and Fig. A7). 70-80% of total municipal biowaste was collected and transported to central dumpsites (in C1 a more developed landfill); the rest was disposed of in informal dumpsites, burned or fed to animals. Source-segregated biowaste collection existed only in C2 where collected biowaste was, however, disposed of due to lacking treatment facilities (Fig. 2C). In C1 an unknown fraction of mixed MSW was mechanically segregated at the landfill and composted, but most of the compost was disposed of due to quality and acceptance issues. Of the total municipal biowaste generation, ca. 9-26 kg<sub>TS</sub> inh<sup>-1</sup> yr<sup>-1</sup> were taken up by land or water and 3-9 kg inh<sup>-1</sup> yr<sup>-1</sup> emitted as smoke (Fig. 3A-F).

Manure dropped in stables was applied as organic fertilizer (37-61 kg<sub>TS</sub> inh<sup>-1</sup> yr<sup>-1</sup> in villages and 1-2 kg<sub>TS</sub> inh<sup>-1</sup> yr<sup>-1</sup> in towns and cities, Fig. 3A-F). 60-80% of crop residues were used as animal feed, cooking fuel and/or soil enhancer; the rest was burned or left nearby fields. Through open burning of crop residues ca. 5-10 kg inh<sup>-1</sup> yr<sup>-1</sup> were emitted as smoke in villages and towns (Fig. 3A-F).

### 3.2. Energy and fertilizer potential of AD of available biowaste

The biogas and digestate potential of available biowaste is indicated as patterns in Fig. 3G-L (standard estimate, lower and maximum estimates in Tables A12-A14). Due to mass conservation in MFA, the sum of products (digestate and biogas) and emissions (leaks) equals available biowaste Formulae 4-6, which was 5-14 kg<sub>TS</sub> inh<sup>-1</sup> yr<sup>-1</sup> municipal biowaste, 1-61 kg<sub>TS</sub> inh<sup>-1</sup> yr<sup>-1</sup> manure and <1-23 kg<sub>TS</sub> inh<sup>-1</sup> yr<sup>-1</sup> crop residues (sum of patterns in Fig. 3G-L, emissions from biogas leaks are included in 'to air'; standard estimates of available biowaste in Table A12).

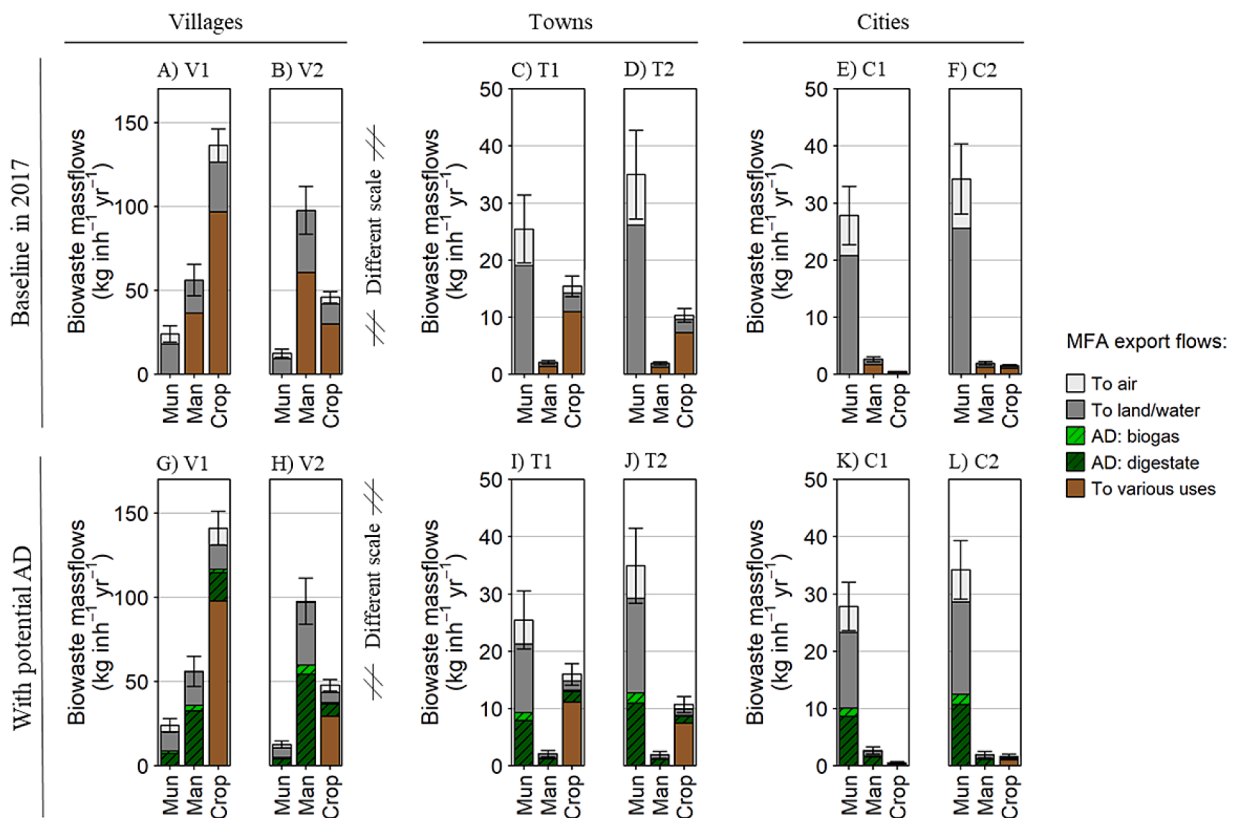

Fig. 3. MFA export flows of biowaste management to the environment (air or land/water), as AD products (biogas, digestate) and to various uses in the baseline in 2017 (A-F) and after potential AD of all available biowaste (G-L, Formula 4-6), values in kg<sub>TS</sub> inh<sup>-1</sup> yr<sup>-1</sup> (solids and liquids) or kg inh<sup>-1</sup> yr<sup>-1</sup> (smoke and gases) ± s.d.; Mun = municipal biowaste, Man = manure and Crop = crop residues.

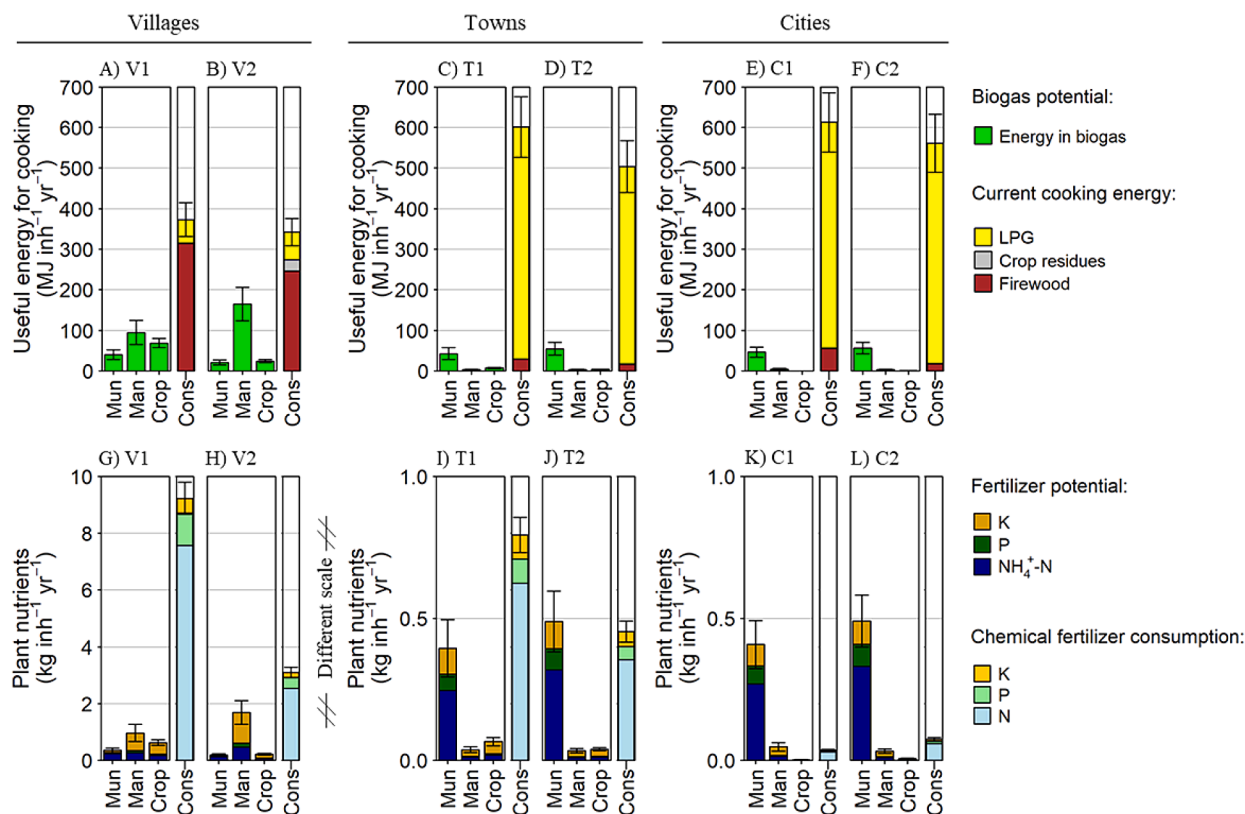

Fig. 4. Biogas potential for cooking per biowaste type (Formula 10) vs. current cooking energy consumption (Formula 11) as useful energy for cooking (value ± s.d., A-F); G-L: fertilizer potential per biowaste type (Formula 12) and chemical fertilizer consumption (Formula 13) as plant nutrients (value ± s.d., G-L); Mun = municipal biowaste, Man = manure, Crop = crop residues and Cons = consumption in 2017.

Table 4

Wet weight and TS of available biowaste (Mun = municipal biowaste, Man = manure and Crop = crop residues), energy in- and output, and water input to treat available biowaste in wet or dry AD; energy output = potential of useful energy for cooking (Formula 10); ± s.d.

Community	Bio-waste	Wet weight (kg inh <sup>-1</sup> yr <sup>-1</sup> )	TS (kg <sub>TS</sub> inh <sup>-1</sup> yr <sup>-1</sup> )	Energy			Water	
				Input (MJ inh <sup>-1</sup> yr <sup>-1</sup> )	Output (MJ inh <sup>-1</sup> yr <sup>-1</sup> )	Input/ Output (%)	Wet AD (L inh <sup>-1</sup> yr <sup>-1</sup> )	Dry AD (L inh <sup>-1</sup> yr <sup>-1</sup> )
V1	Mun	31±8	10±3	13±3	40±12			1
	Man	174±54	35±11	0±0	95±29			*
	Crop	30±4	23±3	28±3	69±11			47
	Total	235±65	68±11	41±4	203±34	20	328	164*
V2	Mun	21±5	5±1	7±2	21±6			<1
	Man	303±74	61±15	0±0	165±41			*
	Crop	11±1	8±1	10±2	24±4			17
	Total	335±81	74±15	17±3	210±41	8	281	220*
T1	Mun	31±10	10±3	15±3	42±15			3
	Man	7±2	1±0	0±0	4±1			*
	Crop	3±1	2±0	3±1	7±2			5
	Total	41±12	14±3	18±3	53±15	34	76	13*
T2	Mun	54±14	13±3	20±3	54±16			<1
	Man	6±1	1±0	0±0	3±1			*
	Crop	2±0	1±0	2±1	4±1			3
	Total	62±15	16±3	21±3	62±16	34	70	7*
C1	Mun	36±8	11±3	16±3	46±13			1
	Man	9±3	2±1	0±0	5±1			*
	Crop	0±0	0±0	<1	<1			<1
	Total	45±11	13±3	16±3	51±13	31	63	8*
C2	Mun	44±9	14±3	20±3	57±14			2
	Man	9±1	2±0	0±0	3±1			*
	Crop	0±0	0±0	<1	1±0			<1
	Total	53±10	16±3	20±3	61±14	33	78	9*

\* Dry AD was not considered for manure, total includes dry AD of municipal biowaste and crop residues plus wet AD of manure



The potential of useful energy for cooking ( $EP_w$ , Formula 10) of available municipal biowaste did not vary across municipalities in a predictable way (22-55 MJ  $inh^{-1} yr^{-1}$ ), whereas  $EP_w$  of available agricultural biowaste (manure plus crop residues) was highest in villages (155-190 MJ  $inh^{-1} yr^{-1}$ ) and lowest in cities (5-10 MJ  $inh^{-1} yr^{-1}$ , Fig. 4A-F).

Total  $EP_w$  of all three biowaste types declined from villages to towns and cities from 52-62% to 8-12% of the consumption of useful energy for cooking in 2017 (Fig. 4A-F). Fuel usage for cooking resembled the national situation as firewood dominated in villages and LPG in towns and cities (Fig. 4A-F). In comparison, the electricity potential of available municipal biowaste plus crop residues was 5-15% of household electricity consumption in villages (potential: 35-55 MJ  $inh^{-1} yr^{-1}$ , demand: ca. 380 MJ  $inh^{-1} yr^{-1}$ ) and 2-3% of household electricity consumption in cities (potential: 28-32 MJ  $inh^{-1} yr^{-1}$ , demand: ca. 1,100 MJ  $inh^{-1} yr^{-1}$ , NSSO, 2014).

The fertilizer potential (Formula 12) of all biowaste types combined was ca. 100% higher in villages compared to towns and cities for  $NH_4^+-N$  and P and almost 1,000 times for K due to high K concentrations in manure (Table 2; Fig. 4G-L). Plant nutrients were estimated in the ranges of 0.3-0.7 kg  $NH_4^+-N$ , 0.1-0.2 kg P and 0.1-1.5 kg K  $inh^{-1} yr^{-1}$  in digestate of available biowaste in all municipalities (Fig. 4G-L).

The chemical fertilizer consumption (Formula 13) declined from lower to higher inhabitant density due to lower crop areas per inhabitant (Fig. 4G-L). The fertilizer self-sufficiency potential of digestate from available municipal biowaste and crop residues combined increased from villages to towns to cities from 5-10% to 40-95% to 550-900% of chemical N-fertilizer consumption and from 15-45% to 70-170% to 970-1,400% of chemical P fertilizer consumption (Fig. 4G-L). Manure was already utilized as organic fertilizer in the baseline and was hence unlikely to substitute additional chemical fertilizers.

### 3.3. Energy and water inputs to biowaste management

Energy inputs required for AD of available biowaste are 20% and 8% of potential useful energy for cooking (Formula 10) in villages V1 and V2, respectively, and 31-34% in towns and cities (Table 4). Lower values in villages are due to a high share of household-scale AD of manure, which requires only manual labour. 80-90% of energy inputs are required for AD treatment and biogas post-treatment (upgrading and bottling to bio-CNG) and the remaining 10-20% for biowaste collection and transportation, digestate post-treatment (solid/liquid separation) and digestate transportation (Table A5).

**Table 5**

Biowaste products and uptake by the environment; total solids per inhabitant and year ( $kg_{TS} inh^{-1} yr^{-1}$ , solids and liquids) or mass per inhabitant and year ( $kg inh^{-1} yr^{-1}$ , smoke and gases); P = products, ULW = uptake by land and/or water, UA = uptake by air;  $\pm$  s.d.

Biowaste management	Products or uptake by the environment		Villages		Towns		Cities	
			V1	V2	T1	T2	C1	C2
Baseline (2017)	P	Biogas	<1	<1	<1	<1	<1	<1
		Digestate	<1	<1	<1	<1	<1	<1
		Various uses	133 $\pm$ 8	91 $\pm$ 8	12 $\pm$ 1	9 $\pm$ 1	2 $\pm$ 0	2 $\pm$ 0
	ULW	Mun <sup>1</sup>	18 $\pm$ 2	9 $\pm$ 1	19 $\pm$ 2	26 $\pm$ 2	21 $\pm$ 1	26 $\pm$ 2
		Man <sup>1</sup>	20 $\pm$ 5	37 $\pm$ 7	1 $\pm$ 0	1 $\pm$ 0	1 $\pm$ 0	1 $\pm$ 0
		Crop <sup>1</sup>	30 $\pm$ 2	12 $\pm$ 1	3 $\pm$ 0	2 $\pm$ 0	<1	<1
UA	Smoke	16 $\pm$ 1	7 $\pm$ 1	8 $\pm$ 1	10 $\pm$ 1	7 $\pm$ 1	9 $\pm$ 1	
	Biogas leaks	<0.1	<0.1	<0.1	<0.1	<0.1	<0.1	
With AD of all available biowaste	P	Biogas	6 $\pm$ 1	7 $\pm$ 1	2 $\pm$ 0	2 $\pm$ 0	2 $\pm$ 0	2 $\pm$ 0
		Digestate	57 $\pm$ 5	66 $\pm$ 7	11 $\pm$ 1	13 $\pm$ 1	10 $\pm$ 1	12 $\pm$ 1
		Various uses	98 $\pm$ 6	30 $\pm$ 2	11 $\pm$ 2	7 $\pm$ 1	<1	1 $\pm$ 0
	ULW	Mun <sup>1</sup>	11 $\pm$ 1	6 $\pm$ 1	12 $\pm$ 1	17 $\pm$ 2	13 $\pm$ 1	16 $\pm$ 1
		Man <sup>1</sup>	20 $\pm$ 4	37 $\pm$ 7	1 $\pm$ 0	1 $\pm$ 0	1 $\pm$ 0	1 $\pm$ 0
		Crop <sup>1</sup>	14 $\pm$ 1	6 $\pm$ 1	2 $\pm$ 0	1 $\pm$ 0	<1	<1
	UA	Smoke	9 $\pm$ 1	4 $\pm$ 1	5 $\pm$ 1	6 $\pm$ 1	4 $\pm$ 1	5 $\pm$ 1
		Biogas leaks	0.6 $\pm$ 0.1	0.7 $\pm$ 0.1	0.1 $\pm$ 0.0	0.2 $\pm$ 0.0	0.1 $\pm$ 0.0	0.1 $\pm$ 0.0

<sup>1</sup> Mun = municipal biowaste, Man = manure and Crop = crop residues.

Water inputs required for AD of all available biowaste are 280-330 L  $inh^{-1} yr^{-1}$  in villages and 60-80 L  $inh^{-1} yr^{-1}$  in towns and cities with wet AD (Table 4). With dry AD of municipal biowaste and crop residues, and wet AD of manure, water inputs for AD of all available biowaste are reduced by 22% and 50% in V2 and V1, respectively, and by 80-90% in towns and cities (Table 4). Dry AD for household-scale AD of manure is not sensible due to its high water content, therefore the water saving potential is more limited in villages compared to towns and cities. Water requirements to treat all available biowaste are <3% of current groundwater abstraction in villages and towns with wet AD and up to 2% with dry AD of municipal biowaste and crop residues (Table 4, Fig. 1). In C2, 20% of current groundwater abstraction is needed for wet AD or 2% with dry AD of municipal biowaste and crop residues.

### 3.4. Potential to reduce emissions to the local environment

AD of all available biowaste can reduce uptake of biowaste by land/water by 25-40% compared to the baseline in 2017 (Table 5). The major part of these reduced emissions is shifted to digestate which makes that saving dependent on the subsequent utilization of digestate. If all digestate is utilized in agriculture, emissions of ca. 0.2-0.3 kg  $NH_4^+-N inh^{-1} yr^{-1}$  and 0.1-0.2 kg P  $inh^{-1} yr^{-1}$  can be diverted away from disposal to fertilization of crops (Fig. 4G-L).

Compared to the baseline in 2017, AD of all available biowaste can reduce 50-60% of smoke related to open burning of municipal biowaste and crop residues (Table 5). Leaks during AD would emit 0.6-0.7 kg  $inh^{-1} yr^{-1}$  unburnt biogas (with ca. 50-60% methane content) in villages and 0.1-0.2 kg  $inh^{-1} yr^{-1}$  unburnt biogas in towns and cities (Table 5). Ca. 6-7 kg  $inh^{-1} yr^{-1}$  biogas in villages and 1-2 kg  $inh^{-1} yr^{-1}$  biogas in towns and cities would be contained in biogas products, which after burning are emitted to the air mainly as carbon dioxide ( $CO_2$ ).

### 3.5. Uncertainties and sensitivity to input parameters

Uncertainties of MFA export flows were within  $\pm$  20-45% (= CV) of their value (error bars in Fig. 3A-L, Table A11). Our study capitalized from primary data of biowaste properties sampled in each municipality (Breitenmoser et al., 2018). Main uncertainties in baseline MFAs related to amounts of MSW reported in municipality-level reports ( $\pm$  21%), amounts and utilization of manure taken from another study in India ( $\pm$  21%) and gap filling during stakeholder interviews and workshops ( $\pm$  41%).

For potential biowaste treatment with AD, Indian and international

data sources where used. There is a lack of reported values of full-scale biowaste treatment (e.g. AD, composting) in India, hence uncertainties were relatively high (e.g. translation of BMP values to expected methane outputs in full-scale plants:  $\pm 14\%$ ). While some data are not expected to differ from one country to another (e.g. biogas to bio-CNG,  $\pm 20\%$ ), others may be strongly affected by climatic and other conditions (e.g. fertilizer potential of digestate derived from international studies,  $\pm 42\%$ ).

Applying lower estimates to calculate available biowaste reduced all AD potential estimates presented in Figs. 3-4 by approximately 50%; for manure it was not exactly 50% because of different fractions of manure dropped in stables for cattle and buffalo (Table A12). The maximum estimate, i.e. the energy and fertilizer potential from all biowaste, was 2-3 times higher than the standard estimate (Table A12).

## 4. Discussion

### 4.1. Biowaste availability and readiness of biowaste management for AD

The MSW generation of 64-185 kg inh<sup>-1</sup> yr<sup>-1</sup> (wet weight, Table A1) in the municipalities of this study is within the range of 60-230 kg inh<sup>-1</sup> yr<sup>-1</sup> reported elsewhere in India (Kumar et al., 2017) and MSW management is typical with little biowaste source-segregation, little formal treatment and unsafe disposal and/or open burning. The lacking biowaste source-segregation in most municipalities points to a current barrier that centralized AD will face but which municipalities have to address according to Indian laws (MoEFCC, 2016; Chand Malav et al., 2020). In the meantime, decentral AD at sites of high biowaste availability (e.g. fruit and vegetable markets) with on-site biogas demand (e.g. canteens on markets which typically use gas for cooking) may be more practicable (Voegeli et al., 2008; Hüscher 2017).

Manure and crop residues are abundant in villages and still mostly untapped as energy source (Fig. 3A-F). Cattle and buffalo manure dropped in stables is relatively easy to use in household-scale AD and will not cause resource competition, because digestate has similar fertilizer properties to untreated manure (Möller and Stinner, 2009). 20-40% of crop residues remain unused as animal feed or fertilizer; their collection and treatment may be feasible in some places, especially with water-saving dry AD (Breitenmoser et al., 2018). Sukhesh et al. (2018) review options to establish appropriate nutrient balance and avoid adverse effects from lignin in crop residues during AD through co-digestion with other biowaste and pre-treatment for the Indian context.

The sensitivity analysis showed that the theoretical AD potential of all biowaste ('maximum estimate', Table A12) cannot be linearly scaled to standard and lower estimates. This underpins that contextualized knowledge of biowaste management is essential to quantify available biowaste, provide realistic estimates of the AD potential at the municipality-level and avoid resource use conflicts. Lower estimates of biowaste availability (Table A12) reflect conditions that are more challenging for AD such as a weak implementation of biowaste-source segregation or a reduction of the biowaste fraction in MSW. The requirement for biowaste source-segregation in Indian solid waste laws, growing awareness of environmental pollution and initiatives such as the 'Swachh Bharat (clean India) Mission' provide opportunities for AD and better waste management in general (Breitenmoser et al., 2019).

### 4.2. Renewable energy supply

Indian policies emphasize the possible contribution of AD to a universal access to affordable, secure and renewable energy sources, as required by national energy policies and sustainable development goal 7 (MoP, 2017; United Nations, 2015). Our study identifies common energy sustainability challenges in municipalities, including a high dependence on firewood for cooking in villages and on fossil fuels in towns and cities (Fig. 4A-F).

AD of available municipal biowaste, manure and crop residues can substitute 50-60% of final energy for cooking in villages and about 10% of final energy for cooking in towns and cities. While in villages all three biowaste types have significant energy potentials, in cities only municipal biowaste is relevant (Fig. 4A-F). Household-scale AD of manure dropped in stables as supported by the 'New National Biogas and Organic Manure Programme' (Table 1) can theoretically substitute 1/3 to 2/3 of firewood (or 25-55% of the useful energy for cooking of all fuels) in the villages of this study (Fig. 4A-B). This AD type is very common in India for energy supply in rural households (Breitenmoser et al., 2019). In addition, decentral AD of crop residues can supply up to 15% of cooking energy (Fig. 4A-B) or 10% of electricity for household appliances in villages. Such decentral plants may be particularly suitable to tackle innovations such as bio-CNG, for which the 'Research, Development and Demonstration' programme provides financial incentives (Table 1). Centralized AD from municipal biowaste can substitute ca. 4-6% of the current consumption of useful energy for cooking (Fig. 4A-F) provided that legally mandated biowaste source-segregation is implemented (MoEFCC, 2016).

Although conversion to electricity has a low efficiency because 2/3 of the energy in biogas will be converted to heat, this may still be a practical solution until bio-CNG technology for cooking or alternatively as car fuel is widely available and proven in India (Mittal et al., 2018). Applied research should target bio-CNG technologies and its integration into the existing LPG cylinder distribution network (Kapdi et al., 2005; Kadam and Panwar, 2017; Twinomunji et al., 2020). Also, the injection of methane from biogas into natural gas grids is an efficient option for large-scale AD (Wellinger et al., 2013), however most Indian municipalities have no grid access (Vaid, 2014).

To treat all available biowaste with AD requires an equivalent of 10-20% of the potential useful energy for cooking in villages and 30-35% in towns and cities (Table 4); differences are mainly due to the high share of manure on the AD potential in villages requiring no energy input. Although the net energy output is positive, this underscores the necessity to promote AD not only for renewable energy supply, but to consider its full value proposition including energy and fertilizer products and pollution control.

### 4.3. Sustainable fertilizer supply

The comparison between fertilizer potential vs. consumption shows a reverse picture from energy with the smallest potential in villages. In towns the fertilizer potential almost meets demand and in cities it exceeds demand by far (Fig. 4G-L). Digestate valorisation from municipal biowaste and crop residues requires at least basic post-treatment to reduce wetness, volatile fatty acids and/or pathogens, as well as storage and transportation (Al Seadi et al., 2013). While low-cost options are available (e.g. solid/liquid separation), finding affordable land for storage is difficult in urban areas (Kothari et al., 2014; Tiwary et al., 2015). Dewatering and post-composting of digestate leads to nutrient loss regarding N-species (Möller and Müller, 2012), but seems a reasonable way to valorise digestate beyond municipal boundaries. In addition, the relatively dry digestate from dry AD may enhance transportability (Kothari et al., 2014).

The utilization of treated municipal biowaste as digestate and compost is encouraged in Solid Waste Management Rules, the Mission on Sustainable Agriculture, and the Policy on the Promotion of City Compost (GoI, 2014; MOCF, 2017). Although compost and digestate still play minor roles as fertilizers in India, encouraging small- to medium-scale composting and AD plants exist in various places where local initiatives and incentives by the local government (e.g. provision of affordable/free land) have been important drivers (Zurbrugg et al., 2004; Chand Malav et al., 2020).

A dependable and proven product quality may be a key to improve acceptance and marketability, and to avoid adverse effects on soils and crops (Chander, 2016; Ghosh and Di Maria, 2018). Even though the

Indian Fertilizer Control Order provides quality guidelines for 'organic fertilizers', there seems to be a lack of quality control through certified laboratories required to measure nutrient and pollutant contents (MoA, 2009). A composting plant at the landfill in city C1 illustrates this, since quality problems were the main reason for disposal of the compost according to operators. Applied agricultural studies on nutrient availability in digestate and possible soil risks with different biowaste types, operational parameters, crops and soils are needed in India to minimize risks and build trust among farmers.

#### 4.4. Water resources

Sustaining water needs for humans and ecosystems is challenging in many regions in India, which is likely to be exacerbated with climate change (UNICEF et al., 2013). Water inputs for treatment of all available biowaste with wet AD are up to 20% (in five out of six municipalities <3%) of current groundwater abstraction, which underlines the need for careful planning of biowaste management in the context of water supply (Table 4). Dry AD would reduce water requirements to < 3% of groundwater abstraction in all municipalities and seems particularly reasonable for dry substrates such as crop residues from which it at least matches biogas production of wet AD (Vandevivere et al., 2003; Kothari et al., 2014). Instead of fresh water, wastewater could be used to dilute biowaste, which may however limit the usability of the digestate in agriculture due to heavy metals, pharmaceutical residues and other hazards for the environment (Singh and Agrawal, 2007).

Water use efficiency is currently not dealt with in MSW rules (UNICEF et al., 2013, CPHEEO, 2016) and our findings suggest that future projects should critically reflect seasonal water availability.

#### 4.5. Potential impacts on local and global ecosystems and public health

Current biowaste management in Indian municipalities leads to large amounts of untreated biowaste going to dumpsites, which can be cut by half with AD of all available biowaste (Fig. 3A-F, Table 5; Kumar et al., 2017). Reducing disposal on unprotected dumpsites helps reducing leachates of nutrients (Table 2) and pollutants to the environment and minimize GHG emissions from anaerobic biowaste degradation (e.g. Bogner et al., 2008; Wiedinmyer et al., 2014). Additionally, decentral dry AD of crop residues with optional co-digestion of municipal biowaste provides an intriguing solution to reduce smoke, return nutrients to agriculture and contribute to renewable energy supply (Sfez et al., 2017; Kothari et al., 2014).

To avoid a shift of emissions from dumpsites to water bodies or agriculture, a safe valorisation of digestate deserves more attention because its utilization can partially substitute energy-intensive (N) and globally limited (P) chemical fertilizers. Particularly when digestate availability exceeds fertilizer demand in highly populated areas (Fig. 4K-L), emissions to the local environment can only be significantly reduced when surplus digestate is exported, e.g. to surrounding agricultural villages.

For biogas, the substitution of firewood for cooking is particularly promising in poor households in rural villages, because this will help reduce indoor air pollution, forest degradation and firewood collection (Lewis et al., 2017; Sfez et al., 2017).

Emissions to air during AD operation and energy conversion of biogas depend on technology design, operations and long-term maintenance. Bruun et al. (2014) have shown that household scale AD in India lose on average 10% of biogas, which due to unburnt methane is a ca. 28 times stronger GHG than burned biogas which consists mainly of CO<sub>2</sub> (Bruun et al., 2014; Pachauri et al., 2014). However, also untreated manure releases methane during storage and AD offers a way of capturing emissions for energy conversion (Dumont et al., 2013). For municipal biowaste and other substrates, well-maintained AD plants were found to save GHG in Europe (Pucker et al., 2013). Given the unsafe disposal in India on dumpsites causing methane emissions

(Bogner et al., 2008), it seems unlikely that AD will cause significant additional GHG emissions. It is nevertheless important to ensure long-term maintenance of AD plants to keep GHG emissions to a minimum, minimize odour emissions and avoid system failures.

Compared against other options for biowaste management, various studies have shown that a reduction of biowaste and direct use of biowaste (e.g. as animal feed were allowed) are the most environmentally sound options (e.g. Salemdeeb et al., 2017; Kibler et al., 2018). It is therefore crucial that biowaste which is already directly used (e.g. to feed animals) is excluded from the AD potential (Fig. 3A-F). MFAs are a useful starting point for LCA studies in Indian municipalities to compare AD against other options of biowaste treatment such as composting or vermicomposting.

## 5. Conclusions

Our study aims to show that the municipality-level assessment of biowaste management in the context of energy, fertilizers, water and the environment reveals benefits, barriers and trade-offs which may be overlooked in simpler country-level waste-to-energy approaches. The following may be concluded:

- Household-scale AD of manure can substantially contribute to energy supply in rural households and reduce firewood dependency;
- crop residues are best treated in water-saving dry AD to supply energy and reduce smoke from post-harvest burning in rural areas;
- organic fertilizer supply and pollution abatement may be equally important selling propositions as renewable energy for mid- to large-scale AD;
- decentral AD at sites of high biowaste availability with local energy demand for cooking and safe water supply seems favourable until source-segregated biowaste collection is established;
- agricultural studies should address digestate valorisation in India, including nutrient use efficiency, soil health and acceptance;
- the approach and tools in this study are tailored for municipalities, use freely available software and may be hence be useful for local planners.

## Declaration of Competing Interest

The authors declare that they have no known competing financial interests or personal relationships that could have appeared to influence the work reported in this paper.

## Acknowledgements

We are thankful to officials, researchers and other persons of the study municipalities who helped us to acquire data and review initial MFA models. We acknowledge financial contributions by the Swiss National Science Foundation (Project No IZLIZ2\_156448/1) and the Department of Science and Technology, Government of India, New Delhi (Project No GAP-1-2102).

## Supplementary materials

Supplementary material associated with this article can be found, in the online version, at [doi:10.1016/j.resconrec.2021.105569](https://doi.org/10.1016/j.resconrec.2021.105569).

## References

- Al Seadi, T., Drogg, B., Fuchs, W., Rutz, D., Janssen, R., 2013. Biogas digestate quality and utilization. In: Wellinger, A., Murphy, J., Baxter, D. (Eds.), *The Biogas Handbook. Science, Production and Applications*. Woodhead Publishing Limited, Cambridge.
- Bogner, J., Pipatti, R., Hashimoto, S., Diaz, C., Mareckova, K., Diaz, L., Kjeldsen, P., Monni, S., Faaij, A., Gao, Qingxian, Zhang, Tianzhu, Ahmed, Mohammed Abdelrafie, Sutamihardja, RTM, Gregory, R., 2008. Mitigation of global greenhouse gas emissions from waste: conclusions and strategies from the Intergovernmental Panel on Climate

- Change (IPCC) Fourth Assessment Report. Working Group III (Mitigation). Waste Manag. Res. 26, 11–32. <https://doi.org/10.1177/0734242X07088433>.
- Breitenmoser, L, Dhar, H, Gross, T, Bakre, M, Huesch, R, Hugi, C, Wintgens, T, Kumar, R, Kumar, S, 2018. Methane potential from municipal biowaste: Insights from six communities in Maharashtra, India. *Bioresour. Technol.* 254, 224–230. <https://doi.org/10.1016/j.biortech.2018.01.074>.
- Breitenmoser, L, Gross, T, Huesch, R, Rau, J, Dhar, H, Kumar, S, Hugi, C, Wintgens, T, 2019. Anaerobic digestion of biowastes in India: Opportunities, challenges and research needs. *J. Environ. Manage.* 236, 396–412. <https://doi.org/10.1016/j.jenvman.2018.12.014>.
- Bruun, S, Jensen, LS, Khanh Vu, VT, Sommer, S, 2014. Small-scale household biogas digesters: An option for global warming mitigation or a potential climate bomb? *Renew. Sustain. Energy Rev.* 33, 736–741. <https://doi.org/10.1016/j.rser.2014.02.033>.
- CEA (2017) Growth of electricity sector in India from 1947. Government of India, Ministry of Power, Central Electricity Authority (CEA), New Delhi.
- Cencic, O, Rechberger, H, 2008. *Material flow analysis with software STAN*. *J. Environ. Eng. Manag.* 18, 3–7.
- CGWB (2009) Ground water information Thane District, Maharashtra. Central Ground Water Board (CGWB), Ministry of Water Resources, Government of India, New Delhi.
- CGWB (2013) Ground water information Nagpur District, Maharashtra. Central Ground Water Board (CGWB), Ministry of Water Resources, Government of India, New Delhi.
- Chand Malav, L, Yadav, KK, Gupta, N, Kumar, S, Sharma, GK, Krishnan, S, Rezanian, S, Kamyab, H, Pham, QB, Yadav, S, Bhattacharyya, S, Yadav, VK, Bach, Q-V, 2020. A review on municipal solid waste as a renewable source for waste-to-energy project in India: Current practices, challenges, and future opportunities. *J. Clean. Prod.* 277, 123227 <https://doi.org/10.1016/j.jclepro.2020.123227>.
- Chander, S, 2016. City compost for swachh bharat. *Indian J Fertil* 16, 12–13.
- CPCB (2018) Implementation of solid waste management rules, 2016. Consolidated annual report. Ministry of Environment, Forests and Climate Change, Central Pollution Control Board (CPCB), New Delhi.
- CPHEEO (2016) Municipal solid waste management manual. Part II: the manual. Central Public Health and Environmental Engineering Organisation (CPHEEO), Ministry of Urban Development, Government of India, New Delhi.
- DAHD (2012) 19th livestock census district wise report. Department of Animal Husbandry, Dairying and Fisheries (DAHD), Government of India, New Delhi.
- Dumont, M, Luning, L, Yildiz, I, Koop, K, 2013. 11 - Methane emissions in biogas production. In: Wellinger, A, Murphy, J, Baxter, D (Eds.), *The Biogas Handbook. Science, Production and Applications*. Woodhead Publishing Limited, Cambridge.
- Evangelisti, S, Lettieri, P, Borello, D, Clift, R, 2014. Life cycle assessment of energy from waste via anaerobic digestion: A UK case study. *Waste Manag.* 34, 226–237. <https://doi.org/10.1016/j.wasman.2013.09.013>.
- FAO, 2006. *Fertilizer use by crop*. FAO Fertil Plant Nutr Bull 17. Food and Agriculture Organization of the United Nations, Rome.
- FOEN (2016) Composting and anaerobic digestion plants. Assessment in Switzerland and Liechtenstein [original German: 'Kompostier- und Vergärungsanlagen. Erhebung in der Schweiz und Liechtenstein']. Swiss Federal Office for the Environment, Berne.
- Gadde, B, Bonnet, S, Menke, C, Garivait, S, 2009. Air pollutant emissions from rice straw open field burning in India, Thailand and the Philippines. *Environ. Pollut.* 157, 1554–1558. <https://doi.org/10.1016/j.envpol.2009.01.004>.
- Ghosh, Sadhan Kumar, Di Maria, Francesco, 2018. A comparative study of issues, challenges and strategies of bio-waste management in India and Italy. *Detritus* 1, 8–17. <https://doi.org/10.26403/detritus/2018.8>.
- GoI (2001) Primary census abstract data tables. Ministry of Home Affairs, Office of the Registrar General, New Delhi.
- GoI (2011a) Census of India 2011. Provisional population totals. Some concepts and definitions. Government of India, Ministry of Home Affairs, Office of the Registrar General, New Delhi.
- GoI (2011b) Census of India 2011. Provisional population totals, urban agglomerations and cities. Office of the Registrar General & Census Commissioner, Ministry of Home Affairs, Government of India, New Delhi.
- GoI (2011c) Table HH-10: Households by availability of separate kitchen and type of fuel used for cooking. Ministry of Home Affairs, Office of the Registrar General, New Delhi.
- GoI (2011d) Primary census abstract data tables. Ministry of Home Affairs, Office of the Registrar General, New Delhi.
- GoI (2011e) Table HH-14: Percentage of households to total households by amenities and assets (India & States/UTs - village and ward level) - Nagpur. Ministry of Home Affairs, Office of the Registrar General, New Delhi.
- GoI (2011f) Table HH-14: Percentage of households to total households by amenities and assets (India & States/UTs - village and ward level) - Thane. Ministry of Home Affairs, Office of the Registrar General, New Delhi.
- GoI (2014) National mission for sustainable agriculture (NMSA). Department of Agriculture and Cooperation, Ministry of Agriculture, New Delhi.
- GoI, 2015. *India's Intended Nationally Determined Contribution: Working Towards Climate Justice*. Government of India, New Delhi.
- Hüsch, R, 2017. *Decentralised biogas plants using market and food waste in the urban Indian context: a case study from Nagpur*. Master thesis. University of Applied Sciences and Arts Northwestern Switzerland, Muttenz.
- Hiloidhari, M, Das, D, Baruah, DC, 2014. Bioenergy potential from crop residue biomass in India. *Renew. Sustain. Energy Rev.* 32, 504–512. <https://doi.org/10.1016/j.rser.2014.01.025>.
- ICRISAT (2014) Agricultural production per district. Village dynamics in South Asia (VDSA). International Crops Research Institute for the Semi-Arid Tropics, Hyderabad, India.
- IPCC, 2006. *2006 IPCC guidelines for national greenhouse gas inventories. volume 5 waste*. The Intergovernmental Panel on Climate Change. IGES, Japan.
- ISWA, UNEP (2015) Global waste management outlook. International Solid Waste Association (ISWA) and United Nations Environmental Programme (UNEP), Nairobi.
- Kadam, R, Panwar, NL, 2017. Recent advancement in biogas enrichment and its applications. *Renew. Sustain. Energy Rev.* 73, 892–903. <https://doi.org/10.1016/j.rser.2017.01.167>.
- Kapdi, SS, Vijay, VK, Rajesh, SK, Prasad, R, 2005. Biogas scrubbing, compression and storage: Perspective and prospectus in Indian context. *Renew. Energy* 30, 1195–1202. <https://doi.org/10.1016/j.renene.2004.09.012>.
- Katakai, S, Hazarika, S, Baruah, DC, 2017. Assessment of by-products of bioenergy systems (anaerobic digestion and gasification) as potential crop nutrient. *Waste Manag.* 59, 102–117. <https://doi.org/10.1016/j.wasman.2016.10.018>.
- Kern M, Raussen T, Funda K, Lootsma A, Hofmann H (2010) Costs and benefits of optimised biowaste utilisation in terms of energy efficiency, climate and resource protection [original German: 'Aufwand und Nutzen einer optimierten Bioabfallverwertung hinsichtlich Energieeffizienz, Klima- und Ressourcenschutz']. Umweltbundesamt, Dessau-Rosslau, Germany.
- Kibler, KM, Reinhart, D, Hawkins, C, Motlagh, AM, Wright, J, 2018. Food waste and the food-energy-water nexus: A review of food waste management alternatives. *Waste Manag.* 74, 52–62. <https://doi.org/10.1016/j.wasman.2018.01.014>.
- Klinglmair, M, Vadenbo, C, Astrup, TF, Scheutz, C, 2017. An MFA-based optimization model for increased resource efficiency: Phosphorus flows in Denmark. *Resour. Conserv. Recycl.* 122, 1–10. <https://doi.org/10.1016/j.resconrec.2017.01.012>.
- Kothari, R, Pandey, AK, Kumar, S, Tyagi, VV, Tyagi, SK, 2014. Different aspects of dry anaerobic digestion for bio-energy: an overview. *Renew. Sustain. Energy Rev.* 39, 174–195. <https://doi.org/10.1016/j.rser.2014.07.011>.
- Krishania, M, Vijay, VK, Chandra, R, 2013. Methane fermentation and kinetics of wheat straw pretreated substrates co-digested with cattle manure in batch assay. *Energy* 57, 359–367. <https://doi.org/10.1016/j.energy.2013.05.028>.
- Kumar, S, Smith, SR, Fowler, G, Velis, C, Kumar, SJ, Arya, S, Rena, Kumar R, Cheeseman, C, 2017. Challenges and opportunities associated with waste management in India. *R. Soc. Open Sci.* 4, 160764 <https://doi.org/10.1098/rsos.160764>.
- Kumari, K, Kumar, S, Rajagopal, V, Khare, A, Kumar, R, 2017. Emission from open burning of municipal solid waste in India. *Environ. Technol. (United Kingdom)* 33(30), 1–14. <https://doi.org/10.1080/09593330.2017.1351489>.
- Laner, D, Feketitsch, J, Rechberger, H, Fellner, J, 2016. A novel approach to characterize data uncertainty in material flow analysis and its application to plastics flows in Austria. *J. Ind. Ecol.* 20, 1050–1063. <https://doi.org/10.1111/jiec.12326>.
- Lewis, JJ, Hollingsworth, JW, Chartier, RT, Cooper, EM, Foster, WM, Gomes, GL, Kussin, PS, MacInnis, JJ, Padhi, BK, Panigrahi, P, Rodes, CE, Ryde, IT, Singha, AK, Stapleton, HM, Thornburg, J, Young, CJ, Meyer, JN, Pattanayak, SK, 2017. Biogas Stoves Reduce Firewood Use, Household Air Pollution, and Hospital Visits in Odisha, India. *Environ. Sci. Technol.* 51, 560–569. <https://doi.org/10.1021/acs.est.6b02466>.
- Lin, L, Xu, F, Ge, X, Li, Y, 2018. Improving the sustainability of organic waste management practices in the food-energy-water nexus: A comparative review of anaerobic digestion and composting. *Renew. Sustain. Energy Rev.* 89, 151–167. <https://doi.org/10.1016/j.rser.2018.03.025>.
- Lissens, G, Vandevivere, P, De Baere, L, Biey, EM, Verstraete, W, 2001. Solid waste digestors: Process performance and practice for municipal solid waste digestion. *Water. Sci. Technol.* 44, 91–102. <https://doi.org/10.2166/wst.2001.0473>.
- Lohri, CR, Diener, S, Zabaleta, I, Mertenat, A, Zurbrugg, C, 2017. Treatment technologies for urban solid biowaste to create value products: A review with focus on low- and middle-income settings. *Rev. Environ. Sci. Biotechnol.* 16, 81–130. <https://doi.org/10.1007/s11157-017-9422-5>.
- Möller, K, Müller, T, 2012. Effects of anaerobic digestion on digestate nutrient availability and crop growth: a review. *Eng. Life Sci.* 12, 242–257. <https://doi.org/10.1002/elsc.201100085>.
- Möller, K, Stinner, W, 2009. Effects of different manuring systems with and without biogas digestion on soil mineral nitrogen content and on gaseous nitrogen losses (ammonia, nitrous oxides). *Eur. J. Agron.* 30, 1–16. <https://doi.org/10.1016/j.eja.2008.06.003>.
- Möller, K, 2016. *Assessment of alternative phosphorus fertilizers for organic farming: compost and digestates from urban organic wastes*. Improve-P, Hohenheim.
- Mertenat, A, Diener, S, Zurbrugg, C, 2019. Black soldier fly biowaste treatment – assessment of global warming potential. *Waste Manag.* 84, 173–181. <https://doi.org/10.1016/j.wasman.2018.11.040>.
- Mittal, S, Ahlgren, EO, Shukla, PR, 2018. Barriers to biogas dissemination in India: a review. *Energy Policy* 112, 361–370. <https://doi.org/10.1016/j.enpol.2017.10.027>.
- MMRDA, NEERI (2011) Development of Regional Municipal Solid Waste Management in MMR. Waste characterization study for MMR. Mumbai Metropolitan Region Development Authority and National Environmental Engineering Research Institute, Nagpur, India.
- MNRE (2014) National biogas and manure management programme (NBMMP). Ministry of New and Renewable Energy (MNRE), Government of India, New Delhi.
- MNRE (2018a) Programme on energy from urban, industrial and agricultural waste/residues for 2017-18, 2018-19 and 2019-20. Ministry of New and Renewable Energy (MNRE), Government of India, New Delhi.
- MNRE (2018b) Administrative sanction cum guidelines for implementation of the central sector scheme, biogas based power generation and thermal application programme (BPGTP) during 2017-18 to 2019-20 (beyond 12th five year plan period). Ministry of New and Renewable Energy (MNRE), Government of India, New Delhi.

- MNRE (2019a) Terms of reference (ToR) for third party evaluation of the central sector scheme - the New National Biogas and Organic Manure Programme (NNBOMP). Ministry of New and Renewable Energy, Government of India, New Delhi.
- MNRE (2019b) Annual report 2018-19. Ministry of New and Renewable Energy (MNRE), Government of India, New Delhi.
- MoA (2009) Biofertilizers and organic fertilizers covered in fertilizer (control) order, 1985, amendment March 2006 and further amendment November 2009. National Centre of Organic Farming, Department of Agriculture and Cooperation, Ministry of Agriculture, Government of India, Uttar Pradesh.
- MOCF (2017) Implementation of policy on promotion of city compost. Ministry of chemicals and fertilizers (MOCF), Government of India, New Delhi.
- MoEFCC (2016) Solid waste management rules. Ministry of Environment, Forest and Climate Change (MoEFCC), Government of India, New Delhi.
- MoP (2017) Draft national energy policy. Ministry of Power, Government of India, New Delhi.
- MOSPI, 2017. Energy statistics 2017. Ministry of Statistics and Programme Implementation. Central Statistics Office, Government of India, New Delhi.
- Nkoa, R, 2014. Agricultural benefits and environmental risks of soil fertilization with anaerobic digestates: a review. *Agron. Sustain. Dev.* 34, 473–492. <https://doi.org/10.1007/s13593-013-0196-z>.
- NRSC, NESAC (2012) National land use and land cover mapping using multitemporal AWiFS data. National Remote Sensing Center (NRSC) and North Eastern Space Applications Centre (NESAC), Hyderabad.
- NSSO (2014) Household consumption of various goods and services in India 2011-12. National Sample Survey Organisation (NSSO), Ministry of Statistics and Programme Implementation, Government of India, New Delhi.
- Pöschl, M, Ward, S, Owende, P, 2010. Evaluation of energy efficiency of various biogas production and utilization pathways. *Appl. Energy* 87, 3305–3321. <https://doi.org/10.1016/j.apenergy.2010.05.011>.
- Pachauri, RK, Allen, MR, Barros, VR, Broome, J, Cramer, W, Christ, R, Church, JA, Clarke, L, Dahe, Q, Dasgupta, P, 2014. Climate change 2014: synthesis report. Contribution of Working Groups I, II and III to the fifth assessment report of the Intergovernmental Panel on Climate Change. The Intergovernmental Panel on Climate Change. IGES, Japan.
- Pucker, J, Jungmeier, G, Siegl, S, Po, EM, 2013. Anaerobic digestion of agricultural and other substrates – implications for greenhouse gas emissions. *Animal* 7, 283–291. <https://doi.org/10.1017/S1751731113000840>.
- Quantum GIS Development Team (2019) QGIS Geographic Information System. Open Source Geospatial Foundation Project. [www.qgis.org](http://www.qgis.org).
- R Core Team (2017) A language and environment for statistical computing. R Foundation for Statistical Computing, Vienna.
- Rao, PV, Baral, SS, Dey, R, Mutnuri, S, 2010. Biogas generation potential by anaerobic digestion for sustainable energy development in India. *Renew. Sustain. Energy Rev.* 14, 2086–2094. <https://doi.org/10.1016/j.rser.2010.03.031>.
- Ravindranath, NH, Somashekar, HI, Nagaraja, MS, Sudha, P, Sangeetha, G, Bhattacharya, SC, Abdul Salam, P, 2005. Assessment of sustainable non-plantation biomass resources potential for energy in India. *Biomass Bioenergy* 29, 178–190. <https://doi.org/10.1016/j.biombioe.2005.03.005>.
- Rocamora, I, Wagland, ST, Villa, R, Simpson, EW, Fernández, O, Bajón-Fernández, Y, 2020. Dry anaerobic digestion of organic waste: A review of operational parameters and their impact on process performance. *Bioresour. Technol.* 299, 122681. <https://doi.org/10.1016/j.biortech.2019.122681>.
- Saleemdeen, R, zu Ermgassen, EKHJ, Kim, MH, Balmford, A, Al-Tabbaa, A, 2017. Environmental and health impacts of using food waste as animal feed: a comparative analysis of food waste management options. *J. Clean. Prod.* 140, 871–880. <https://doi.org/10.1016/j.jclepro.2016.05.049>.
- Sfez, S, De Meester, S, Dewulf, J, 2017. Co-digestion of rice straw and cow dung to supply cooking fuel and fertilizers in rural India: impact on human health, resource flows and climate change. *Sci. Total Environ.* 609, 1600–1615. <https://doi.org/10.1016/j.scitotenv.2017.07.150>.
- Silva dos Santos, IF, Braz Vieira, ND, de Nóbrega, LGB, Barros, RM, Tiago Filho, GL, 2018. Assessment of potential biogas production from multiple organic wastes in Brazil: impact on energy generation, use, and emissions abatement. *Resour. Conserv. Recycl.* 131, 54–63. <https://doi.org/10.1016/j.resconrec.2017.12.012>.
- Singh RP, Agrawal M (2007) Effects of sewage sludge amendment on heavy metal accumulation and consequent responses of Beta vulgaris plants. 67:2229–2240. doi: 10.1016/j.chemosphere.2006.12.019.
- Singh, P, Gundimeda, H, Stucki, M, 2014. Environmental footprint of cooking fuels: a life cycle assessment of ten fuel sources used in Indian households. *Int. J. Life Cycle Assess.* 19, 1036–1048. <https://doi.org/10.1007/s11367-014-0699-0>.
- Singh, V, Phuleria, HC, Chandel, MK, 2020. Estimation of energy recovery potential of sewage sludge in India: waste to watt approach. *J. Clean. Prod.* 276, 122538 <https://doi.org/10.1016/j.jclepro.2020.122538>.
- Sogn, TA, Dragicevic, I, Linjordet, R, Krogstad, T, Eijsink, VGH, Greatorex, SE, 2018. Recycling of biogas digestates in plant production: NPK fertilizer value and risk of leaching. *Int. J. Recycl. Org. Waste Agric.* 7, 49–58. <https://doi.org/10.1007/s40093-017-0188-0>.
- Sukhesh, MJ, Rao, PV, 2018. Anaerobic digestion of crop residues: Technological developments and environmental impact in the Indian context. *Biocatal. Agric. Biotechnol.* 16, 513–528. <https://doi.org/10.1016/j.bcab.2018.08.007>.
- Surendra, KC, Takara, D, Hashimoto, AG, Khanal, SK, 2014. Biogas as a sustainable energy source for developing countries: opportunities and challenges. *Renew. Sustain. Energy Rev.* 31, 846–859. <https://doi.org/10.1016/j.rser.2013.12.015>.
- Tiwary, A, Williams, ID, Pant, DC, Kishore, VVN, 2015. Emerging perspectives on environmental burden minimisation initiatives from anaerobic digestion technologies for community scale biomass valorisation. *Renew. Sustain. Energy Rev.* 42, 883–901. <https://doi.org/10.1016/j.rser.2014.10.052>.
- Turner, DA, Williams, ID, Kemp, S, 2016. Combined material flow analysis and life cycle assessment as a support tool for solid waste management decision making. *J. Clean. Prod.* 129, 234–248. <https://doi.org/10.1016/j.jclepro.2016.04.077>.
- Twinomunji, E, Kemausuor, F, Black, M, Roy, A, Leach, M, Oduro, R, Sadhukhan, J, Murphy, R, 2020. The potential for bottled biogas for clean cooking in Africa. *Modern Energy Cooking Services (MECS)*. Surrey, UK.
- UNICEF, FAO, SaciWATERS, 2013. Water in India: Situation and Prospects. UNICEF, FAO and SaciWATERS, New Delhi/Andhra Pradesh and.
- United Nations (2015) Transforming our world: the 2030 Agenda for Sustainable Development. General Assembly Resolution 70/1, A/RES/70/1, United Nations, New York.
- Vögeli, Y, Riu, C, Gallardo, A, Diener, S, Zurbrugg, C, 2014. Anaerobic digestion of biowaste in developing countries. *Swiss Federal Institute of Aquatic Science and Technology. Dübendorf, Switzerland*.
- Vaid, M, 2014. India's natural gas infrastructure: reassessing challenges and opportunities. *Strateg. Anal.* 38, 508–527. <https://doi.org/10.1080/09700161.2014.918428>.
- Vandevivere, P, De Baere, L, Verstraete, W, 2003. Types of anaerobic digester for solid wastes. In: Mata-Alvarez, J (Ed.), *Biomethanization of the Organic Fraction of Municipal Solid Wastes*. IWA Press, London, pp. 111–140.
- Voegeli, Y, Zurbrugg, C, 2008. Decentralised anaerobic digestion of kitchen and market waste in developing countries – 'state-of-the-art' in South India. In: *Proceedings of the Second International Symposium on Energy from Biomass and Waste, 2. Venice 17-20 November 2008*.
- Wellinger, A, Murphy, J, Baxter, D, 2013. *The Biogas Handbook. Science, Production and Applications*. Woodhead Publishing Limited, Cambridge.
- Wiedinmyer, C, Yokelson, RJ, Gullett, BK, 2014. Global emissions of trace gases, particulate matter, and hazardous air pollutants from open burning of domestic waste. *Environ. Sci. Technol.* 48, 9523–9530. <https://doi.org/10.1021/es502250z>.
- World Bank, 2018. *What a waste 2.0. The World Bank, Washington DC*.
- Zoboli O, Zessner M, Rechberger H (2016) Supporting phosphorus management in Austria: Potential, priorities and limitations. *Sci. Total Environ.* doi: 10.1016/j.scitotenv.2016.04.171.
- Zurbrugg, C, Drescher, S, Patel, A, HC, S, 2004. Decentralised composting of urban waste – an overview of community and private initiatives in Indian cities. *Waste Manag.* 24, 655–662. <https://doi.org/10.1016/j.wasman.2004.01.003>.